

Operating Manual



Wideband Power Sensor

R&S® NRP-Z81
1137.9009.02

R&S® NRP-Z85
1411.7501.02

R&S® NRP-Z86
1417.0109.40/44

Dear Customer,

R&S® is a registered trademark of Rohde & Schwarz GmbH & Co. KG
Trade names are trademarks of the owners.

Basic Safety Instructions

Always read through and comply with the following safety instructions!

All plants and locations of the Rohde & Schwarz group of companies make every effort to keep the safety standards of our products up to date and to offer our customers the highest possible degree of safety. Our products and the auxiliary equipment they require are designed, built and tested in accordance with the safety standards that apply in each case. Compliance with these standards is continuously monitored by our quality assurance system. The product described here has been designed, built and tested in accordance with the EC Certificate of Conformity and has left the manufacturer's plant in a condition fully complying with safety standards. To maintain this condition and to ensure safe operation, you must observe all instructions and warnings provided in this manual. If you have any questions regarding these safety instructions, the Rohde & Schwarz group of companies will be happy to answer them.



Furthermore, it is your responsibility to use the product in an appropriate manner. This product is designed for use solely in industrial and laboratory environments or, if expressly permitted, also in the field and must not be used in any way that may cause personal injury or property damage. You are responsible if the product is used for any purpose other than its designated purpose or in disregard of the manufacturer's instructions. The manufacturer shall assume no responsibility for such use of the product.

The product is used for its designated purpose if it is used in accordance with its product documentation and within its performance limits (see data sheet, documentation, the following safety instructions). Using the product requires technical skills and, in some cases, a basic knowledge of English. It is therefore essential that only skilled and specialized staff or thoroughly trained personnel with the required skills be allowed to use the product. If personal safety gear is required for using Rohde & Schwarz products, this will be indicated at the appropriate place in the product documentation. Keep the basic safety instructions and the product documentation in a safe place and pass them on to the subsequent users.











Observing the safety instructions will help prevent personal injury or damage of any kind caused by dangerous situations. Therefore, carefully read through and adhere to the following safety instructions before and when using the product. It is also absolutely essential to observe the additional safety instructions on personal safety, for example, that appear in relevant parts of the product documentation. In these safety instructions, the word "product" refers to all merchandise sold and distributed by the Rohde & Schwarz group of companies, including instruments, systems and all accessories. For product-specific information, see the data sheet and the product documentation.

Safety labels on products

The following safety labels are used on products to warn against risks and dangers.

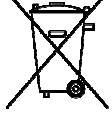
Symbol	Meaning	Symbol	Meaning
	Notice, general danger location Observe product documentation	○	ON/OFF supply voltage
	Caution when handling heavy equipment	⏻	Standby indication
	Danger of electric shock	— — —	Direct current (DC)

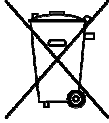
Basic Safety Instructions

Symbol	Meaning	Symbol	Meaning
	Warning! Hot surface		Alternating current (AC)
	Protective conductor terminal		Direct/alternating current (DC/AC)
	Ground		Device fully protected by double (reinforced) insulation
	Ground terminal		EU labeling for batteries and accumulators For additional information, see section "Waste disposal/Environmental protection", item 1.
	Be careful when handling electrostatic sensitive devices		EU labeling for separate collection of electrical and electronic devices For additional information, see section "Waste disposal/Environmental protection", item 2.
	Warning! Laser radiation For additional information, see section "Operation", item 7.		

Signal words and their meaning

The following signal words are used in the product documentation in order to warn the reader about risks and dangers.



Indicates a hazardous situation which, if not avoided, will result in death or serious injury.



Indicates a hazardous situation which, if not avoided, could result in death or serious injury.



Indicates a hazardous situation which, if not avoided, could result in minor or moderate injury.



Indicates information considered important, but not hazard-related, e.g. messages relating to property damage.
In the product documentation, the word ATTENTION is used synonymously.

These signal words are in accordance with the standard definition for civil applications in the European Economic Area. Definitions that deviate from the standard definition may also exist in other economic areas or military applications. It is therefore essential to make sure that the signal words described here are always used only in connection with the related product documentation and the related product. The use of signal words in connection with unrelated products or documentation can result in misinterpretation and in personal injury or material damage.

Basic Safety Instructions

Operating states and operating positions

The product may be operated only under the operating conditions and in the positions specified by the manufacturer, without the product's ventilation being obstructed. If the manufacturer's specifications are not observed, this can result in electric shock, fire and/or serious personal injury or death. Applicable local or national safety regulations and rules for the prevention of accidents must be observed in all work performed.

1. Unless otherwise specified, the following requirements apply to Rohde & Schwarz products: predefined operating position is always with the housing floor facing down, IP protection 2X, use only indoors, max. operating altitude 2000 m above sea level, max. transport altitude 4500 m above sea level. A tolerance of $\pm 10\%$ shall apply to the nominal voltage and $\pm 5\%$ to the nominal frequency, overvoltage category 2, pollution severity 2.
2. Do not place the product on surfaces, vehicles, cabinets or tables that for reasons of weight or stability are unsuitable for this purpose. Always follow the manufacturer's installation instructions when installing the product and fastening it to objects or structures (e.g. walls and shelves). An installation that is not carried out as described in the product documentation could result in personal injury or even death.
3. Do not place the product on heat-generating devices such as radiators or fan heaters. The ambient temperature must not exceed the maximum temperature specified in the product documentation or in the data sheet. Product overheating can cause electric shock, fire and/or serious personal injury or even death.

Electrical safety

If the information on electrical safety is not observed either at all or to the extent necessary, electric shock, fire and/or serious personal injury or death may occur.

1. Prior to switching on the product, always ensure that the nominal voltage setting on the product matches the nominal voltage of the AC supply network. If a different voltage is to be set, the power fuse of the product may have to be changed accordingly.
2. In the case of products of safety class I with movable power cord and connector, operation is permitted only on sockets with a protective conductor contact and protective conductor.
3. Intentionally breaking the protective conductor either in the feed line or in the product itself is not permitted. Doing so can result in the danger of an electric shock from the product. If extension cords or connector strips are implemented, they must be checked on a regular basis to ensure that they are safe to use.
4. If there is no power switch for disconnecting the product from the AC supply network, or if the power switch is not suitable for this purpose, use the plug of the connecting cable to disconnect the product from the AC supply network. In such cases, always ensure that the power plug is easily reachable and accessible at all times. For example, if the power plug is the disconnecting device, the length of the connecting cable must not exceed 3 m. Functional or electronic switches are not suitable for providing disconnection from the AC supply network. If products without power switches are integrated into racks or systems, the disconnecting device must be provided at the system level.
5. Never use the product if the power cable is damaged. Check the power cables on a regular basis to ensure that they are in proper operating condition. By taking appropriate safety measures and carefully laying the power cable, ensure that the cable cannot be damaged and that no one can be hurt by, for example, tripping over the cable or suffering an electric shock.

Basic Safety Instructions

6. The product may be operated only from TN/TT supply networks fuse-protected with max. 16 A (higher fuse only after consulting with the Rohde & Schwarz group of companies).
7. Do not insert the plug into sockets that are dusty or dirty. Insert the plug firmly and all the way into the socket provided for this purpose. Otherwise, sparks that result in fire and/or injuries may occur.
8. Do not overload any sockets, extension cords or connector strips; doing so can cause fire or electric shocks.
9. For measurements in circuits with voltages $V_{rms} > 30$ V, suitable measures (e.g. appropriate measuring equipment, fuse protection, current limiting, electrical separation, insulation) should be taken to avoid any hazards.
10. Ensure that the connections with information technology equipment, e.g. PCs or other industrial computers, comply with the IEC60950-1/EN60950-1 or IEC61010-1/EN 61010-1 standards that apply in each case.
11. Unless expressly permitted, never remove the cover or any part of the housing while the product is in operation. Doing so will expose circuits and components and can lead to injuries, fire or damage to the product.
12. If a product is to be permanently installed, the connection between the protective conductor terminal on site and the product's protective conductor must be made first before any other connection is made. The product may be installed and connected only by a licensed electrician.
13. For permanently installed equipment without built-in fuses, circuit breakers or similar protective devices, the supply circuit must be fuse-protected in such a way that anyone who has access to the product, as well as the product itself, is adequately protected from injury or damage.
14. Use suitable overvoltage protection to ensure that no overvoltage (such as that caused by a bolt of lightning) can reach the product. Otherwise, the person operating the product will be exposed to the danger of an electric shock.
15. Any object that is not designed to be placed in the openings of the housing must not be used for this purpose. Doing so can cause short circuits inside the product and/or electric shocks, fire or injuries.
16. Unless specified otherwise, products are not liquid-proof (see also section "Operating states and operating positions", item 1). Therefore, the equipment must be protected against penetration by liquids. If the necessary precautions are not taken, the user may suffer electric shock or the product itself may be damaged, which can also lead to personal injury.
17. Never use the product under conditions in which condensation has formed or can form in or on the product, e.g. if the product has been moved from a cold to a warm environment. Penetration by water increases the risk of electric shock.
18. Prior to cleaning the product, disconnect it completely from the power supply (e.g. AC supply network or battery). Use a soft, non-linting cloth to clean the product. Never use chemical cleaning agents such as alcohol, acetone or diluents for cellulose lacquers.

Operation

1. Operating the products requires special training and intense concentration. Make sure that persons who use the products are physically, mentally and emotionally fit enough to do so; otherwise, injuries or material damage may occur. It is the responsibility of the employer/operator to select suitable personnel for operating the products.

Basic Safety Instructions

2. Before you move or transport the product, read and observe the section titled "Transport".
3. As with all industrially manufactured goods, the use of substances that induce an allergic reaction (allergens) such as nickel cannot be generally excluded. If you develop an allergic reaction (such as a skin rash, frequent sneezing, red eyes or respiratory difficulties) when using a Rohde & Schwarz product, consult a physician immediately to determine the cause and to prevent health problems or stress.
4. Before you start processing the product mechanically and/or thermally, or before you take it apart, be sure to read and pay special attention to the section titled "Waste disposal/Environmental protection", item 1.
5. Depending on the function, certain products such as RF radio equipment can produce an elevated level of electromagnetic radiation. Considering that unborn babies require increased protection, pregnant women must be protected by appropriate measures. Persons with pacemakers may also be exposed to risks from electromagnetic radiation. The employer/operator must evaluate workplaces where there is a special risk of exposure to radiation and, if necessary, take measures to avert the potential danger.
6. Should a fire occur, the product may release hazardous substances (gases, fluids, etc.) that can cause health problems. Therefore, suitable measures must be taken, e.g. protective masks and protective clothing must be worn.
7. Laser products are given warning labels that are standardized according to their laser class. Lasers can cause biological harm due to the properties of their radiation and due to their extremely concentrated electromagnetic power. If a laser product (e.g. a CD/DVD drive) is integrated into a Rohde & Schwarz product, absolutely no other settings or functions may be used as described in the product documentation. The objective is to prevent personal injury (e.g. due to laser beams).
8. EMC classes (in line with EN 55011/CISPR 11, and analogously with EN 55022/CISPR 22, EN 55032/CISPR 32)
 - Class A equipment:
Equipment suitable for use in all environments except residential environments and environments that are directly connected to a low-voltage supply network that supplies residential buildings
Note: Class A equipment is intended for use in an industrial environment. This equipment may cause radio disturbances in residential environments, due to possible conducted as well as radiated disturbances. In this case, the operator may be required to take appropriate measures to eliminate these disturbances.
 - Class B equipment:
Equipment suitable for use in residential environments and environments that are directly connected to a low-voltage supply network that supplies residential buildings

Repair and service

1. The product may be opened only by authorized, specially trained personnel. Before any work is performed on the product or before the product is opened, it must be disconnected from the AC supply network. Otherwise, personnel will be exposed to the risk of an electric shock.

Basic Safety Instructions

- Adjustments, replacement of parts, maintenance and repair may be performed only by electrical experts authorized by Rohde & Schwarz. Only original parts may be used for replacing parts relevant to safety (e.g. power switches, power transformers, fuses). A safety test must always be performed after parts relevant to safety have been replaced (visual inspection, protective conductor test, insulation resistance measurement, leakage current measurement, functional test). This helps ensure the continued safety of the product.

Batteries and rechargeable batteries/cells

If the information regarding batteries and rechargeable batteries/cells is not observed either at all or to the extent necessary, product users may be exposed to the risk of explosions, fire and/or serious personal injury, and, in some cases, death. Batteries and rechargeable batteries with alkaline electrolytes (e.g. lithium cells) must be handled in accordance with the EN 62133 standard.

- Cells must not be taken apart or crushed.
- Cells or batteries must not be exposed to heat or fire. Storage in direct sunlight must be avoided. Keep cells and batteries clean and dry. Clean soiled connectors using a dry, clean cloth.
- Cells or batteries must not be short-circuited. Cells or batteries must not be stored in a box or in a drawer where they can short-circuit each other, or where they can be short-circuited by other conductive materials. Cells and batteries must not be removed from their original packaging until they are ready to be used.
- Cells and batteries must not be exposed to any mechanical shocks that are stronger than permitted.
- If a cell develops a leak, the fluid must not be allowed to come into contact with the skin or eyes. If contact occurs, wash the affected area with plenty of water and seek medical aid.
- Improperly replacing or charging cells or batteries that contain alkaline electrolytes (e.g. lithium cells) can cause explosions. Replace cells or batteries only with the matching Rohde & Schwarz type (see parts list) in order to ensure the safety of the product.
- Cells and batteries must be recycled and kept separate from residual waste. Rechargeable batteries and normal batteries that contain lead, mercury or cadmium are hazardous waste. Observe the national regulations regarding waste disposal and recycling.

Transport

- The product may be very heavy. Therefore, the product must be handled with care. In some cases, the user may require a suitable means of lifting or moving the product (e.g. with a lift-truck) to avoid back or other physical injuries.
- Handles on the products are designed exclusively to enable personnel to transport the product. It is therefore not permissible to use handles to fasten the product to or on transport equipment such as cranes, fork lifts, wagons, etc. The user is responsible for securely fastening the products to or on the means of transport or lifting. Observe the safety regulations of the manufacturer of the means of transport or lifting. Noncompliance can result in personal injury or material damage.
- If you use the product in a vehicle, it is the sole responsibility of the driver to drive the vehicle safely and properly. The manufacturer assumes no responsibility for accidents or collisions. Never use the product in a moving vehicle if doing so could distract the driver of the vehicle. Adequately secure the product in the vehicle to prevent injuries or other damage in the event of an accident.

Instrucciones de seguridad elementales

Waste disposal/Environmental protection

1. Specially marked equipment has a battery or accumulator that must not be disposed of with unsorted municipal waste, but must be collected separately. It may only be disposed of at a suitable collection point or via a Rohde & Schwarz customer service center.
2. Waste electrical and electronic equipment must not be disposed of with unsorted municipal waste, but must be collected separately.
Rohde & Schwarz GmbH & Co. KG has developed a disposal concept and takes full responsibility for take-back obligations and disposal obligations for manufacturers within the EU. Contact your Rohde & Schwarz customer service center for environmentally responsible disposal of the product.
3. If products or their components are mechanically and/or thermally processed in a manner that goes beyond their intended use, hazardous substances (heavy-metal dust such as lead, beryllium, nickel) may be released. For this reason, the product may only be disassembled by specially trained personnel. Improper disassembly may be hazardous to your health. National waste disposal regulations must be observed.
4. If handling the product releases hazardous substances or fuels that must be disposed of in a special way, e.g. coolants or engine oils that must be replenished regularly, the safety instructions of the manufacturer of the hazardous substances or fuels and the applicable regional waste disposal regulations must be observed. Also observe the relevant safety instructions in the product documentation. The improper disposal of hazardous substances or fuels can cause health problems and lead to environmental damage.

For additional information about environmental protection, visit the Rohde & Schwarz website.

Instrucciones de seguridad elementales

¡Es imprescindible leer y cumplir las siguientes instrucciones e informaciones de seguridad!

El principio del grupo de empresas Rohde & Schwarz consiste en tener nuestros productos siempre al día con los estándares de seguridad y de ofrecer a nuestros clientes el máximo grado de seguridad. Nuestros productos y todos los equipos adicionales son siempre fabricados y examinados según las normas de seguridad vigentes. Nuestro sistema de garantía de calidad controla constantemente que sean cumplidas estas normas. El presente producto ha sido fabricado y examinado según el certificado de conformidad de la UE y ha salido de nuestra planta en estado impecable según los estándares técnicos de seguridad. Para poder preservar este estado y garantizar un funcionamiento libre de peligros, el usuario deberá atenerse a todas las indicaciones, informaciones de seguridad y notas de alerta. El grupo de empresas Rohde & Schwarz está siempre a su disposición en caso de que tengan preguntas referentes a estas informaciones de seguridad.

Además queda en la responsabilidad del usuario utilizar el producto en la forma debida. Este producto está destinado exclusivamente al uso en la industria y el laboratorio o, si ha sido expresamente autorizado, para aplicaciones de campo y de ninguna manera deberá ser utilizado de modo que alguna persona/cosa pueda sufrir daño. El uso del producto fuera de sus fines definidos o sin tener en cuenta las instrucciones del fabricante queda en la responsabilidad del usuario. El fabricante no se hace en ninguna forma responsable de consecuencias a causa del mal uso del producto.















Instrucciones de seguridad elementales

Se parte del uso correcto del producto para los fines definidos si el producto es utilizado conforme a las indicaciones de la correspondiente documentación del producto y dentro del margen de rendimiento definido (ver hoja de datos, documentación, informaciones de seguridad que siguen). El uso del producto hace necesarios conocimientos técnicos y ciertos conocimientos del idioma inglés. Por eso se debe tener en cuenta que el producto solo pueda ser operado por personal especializado o personas instruidas en profundidad con las capacidades correspondientes. Si fuera necesaria indumentaria de seguridad para el uso de productos de Rohde & Schwarz, encontraría la información debida en la documentación del producto en el capítulo correspondiente. Guarde bien las informaciones de seguridad elementales, así como la documentación del producto, y entréguelas a usuarios posteriores.



Tener en cuenta las informaciones de seguridad sirve para evitar en lo posible lesiones o daños por peligros de toda clase. Por eso es imprescindible leer detalladamente y comprender por completo las siguientes informaciones de seguridad antes de usar el producto, y respetarlas durante el uso del producto. Deberán tenerse en cuenta todas las demás informaciones de seguridad, como p. ej. las referentes a la protección de personas, que encontrarán en el capítulo correspondiente de la documentación del producto y que también son de obligado cumplimiento. En las presentes informaciones de seguridad se recogen todos los objetos que distribuye el grupo de empresas Rohde & Schwarz bajo la denominación de "producto", entre ellos también aparatos, instalaciones así como toda clase de accesorios. Los datos específicos del producto figuran en la hoja de datos y en la documentación del producto.

Señalización de seguridad de los productos

Las siguientes señales de seguridad se utilizan en los productos para advertir sobre riesgos y peligros.

Símbolo	Significado	Símbolo	Significado
	Aviso: punto de peligro general Observar la documentación del producto		Tensión de alimentación de PUESTA EN MARCHA / PARADA
	Atención en el manejo de dispositivos de peso elevado		Indicación de estado de espera (standby)
	Peligro de choque eléctrico		Corriente continua (DC)
	Advertencia: superficie caliente		Corriente alterna (AC)
	Conexión a conductor de protección		Corriente continua / Corriente alterna (DC/AC)
	Conexión a tierra		El aparato está protegido en su totalidad por un aislamiento doble (reforzado)
	Conexión a masa		Distintivo de la UE para baterías y acumuladores Más información en la sección "Eliminación/protección del medio ambiente", punto 1.

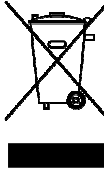
Instrucciones de seguridad elementales

Símbolo	Significado	Símbolo	Significado
	Aviso: Cuidado en el manejo de dispositivos sensibles a la electrostática (ESD)		Distintivo de la UE para la eliminación por separado de dispositivos eléctricos y electrónicos Más información en la sección "Eliminación/protección del medio ambiente", punto 2.
	Advertencia: rayo láser Más información en la sección "Funcionamiento", punto 7.		

Palabras de señal y su significado

En la documentación del producto se utilizan las siguientes palabras de señal con el fin de advertir contra riesgos y peligros.



Indica una situación de peligro que, si no se evita, causa lesiones graves o incluso la muerte.



Indica una situación de peligro que, si no se evita, puede causar lesiones graves o incluso la muerte.



Indica una situación de peligro que, si no se evita, puede causar lesiones leves o moderadas.



Indica información que se considera importante, pero no en relación con situaciones de peligro; p. ej., avisos sobre posibles daños materiales.

En la documentación del producto se emplea de forma sinónima el término CUIDADO.

Las palabras de señal corresponden a la definición habitual para aplicaciones civiles en el área económica europea. Pueden existir definiciones diferentes a esta definición en otras áreas económicas o en aplicaciones militares. Por eso se deberá tener en cuenta que las palabras de señal aquí descritas sean utilizadas siempre solamente en combinación con la correspondiente documentación del producto y solamente en combinación con el producto correspondiente. La utilización de las palabras de señal en combinación con productos o documentaciones que no les correspondan puede llevar a interpretaciones equivocadas y tener por consecuencia daños en personas u objetos.

Estados operativos y posiciones de funcionamiento

El producto solamente debe ser utilizado según lo indicado por el fabricante respecto a los estados operativos y posiciones de funcionamiento sin que se obstruya la ventilación. Si no se siguen las indicaciones del fabricante, pueden producirse choques eléctricos, incendios y/o lesiones graves con posible consecuencia de muerte. En todos los trabajos deberán ser tenidas en cuenta las normas nacionales y locales de seguridad del trabajo y de prevención de accidentes.

Instrucciones de seguridad elementales

1. Si no se convino de otra manera, es para los productos Rohde & Schwarz válido lo que sigue: como posición de funcionamiento se define por principio la posición con el suelo de la caja para abajo, modo de protección IP 2X, uso solamente en estancias interiores, utilización hasta 2000 m sobre el nivel del mar, transporte hasta 4500 m sobre el nivel del mar. Se aplicará una tolerancia de $\pm 10\%$ sobre el voltaje nominal y de $\pm 5\%$ sobre la frecuencia nominal. Categoría de sobrecarga eléctrica 2, índice de suciedad 2.
2. No sitúe el producto encima de superficies, vehículos, estantes o mesas, que por sus características de peso o de estabilidad no sean aptos para él. Siga siempre las instrucciones de instalación del fabricante cuando instale y asegure el producto en objetos o estructuras (p. ej. paredes y estantes). Si se realiza la instalación de modo distinto al indicado en la documentación del producto, se pueden causar lesiones o, en determinadas circunstancias, incluso la muerte.
3. No ponga el producto sobre aparatos que generen calor (p. ej. radiadores o calefactores). La temperatura ambiente no debe superar la temperatura máxima especificada en la documentación del producto o en la hoja de datos. En caso de sobrecalentamiento del producto, pueden producirse choques eléctricos, incendios y/o lesiones graves con posible consecuencia de muerte.

Seguridad eléctrica

Si no se siguen (o se siguen de modo insuficiente) las indicaciones del fabricante en cuanto a seguridad eléctrica, pueden producirse choques eléctricos, incendios y/o lesiones graves con posible consecuencia de muerte.

1. Antes de la puesta en marcha del producto se deberá comprobar siempre que la tensión preseleccionada en el producto coincida con la de la red de alimentación eléctrica. Si es necesario modificar el ajuste de tensión, también se deberán cambiar en caso dado los fusibles correspondientes del producto.
2. Los productos de la clase de protección I con alimentación móvil y enchufe individual solamente podrán enchufarse a tomas de corriente con contacto de seguridad y con conductor de protección conectado.
3. Queda prohibida la interrupción intencionada del conductor de protección, tanto en la toma de corriente como en el mismo producto. La interrupción puede tener como consecuencia el riesgo de que el producto sea fuente de choques eléctricos. Si se utilizan cables alargadores o regletas de enchufe, deberá garantizarse la realización de un examen regular de los mismos en cuanto a su estado técnico de seguridad.
4. Si el producto no está equipado con un interruptor para desconectarlo de la red, o bien si el interruptor existente no resulta apropiado para la desconexión de la red, el enchufe del cable de conexión se deberá considerar como un dispositivo de desconexión. El dispositivo de desconexión se debe poder alcanzar fácilmente y debe estar siempre bien accesible. Si, p. ej., el enchufe de conexión a la red es el dispositivo de desconexión, la longitud del cable de conexión no debe superar 3 m). Los interruptores selectores o electrónicos no son aptos para el corte de la red eléctrica. Si se integran productos sin interruptor en bastidores o instalaciones, se deberá colocar el interruptor en el nivel de la instalación.
5. No utilice nunca el producto si está dañado el cable de conexión a red. Compruebe regularmente el correcto estado de los cables de conexión a red. Asegúrese, mediante las medidas de protección y de instalación adecuadas, de que el cable de conexión a red no pueda ser dañado o de que nadie pueda ser dañado por él, p. ej. al tropezar o por un choque eléctrico.

Instrucciones de seguridad elementales

6. Solamente está permitido el funcionamiento en redes de alimentación TN/TT aseguradas con fusibles de 16 A como máximo (utilización de fusibles de mayor amperaje solo previa consulta con el grupo de empresas Rohde & Schwarz).
7. Nunca conecte el enchufe en tomas de corriente sucias o llenas de polvo. Introduzca el enchufe por completo y fuertemente en la toma de corriente. La no observación de estas medidas puede provocar chispas, fuego y/o lesiones.
8. No sobrecargue las tomas de corriente, los cables alargadores o las regletas de enchufe ya que esto podría causar fuego o choques eléctricos.
9. En las mediciones en circuitos de corriente con una tensión $U_{\text{eff}} > 30 \text{ V}$ se deberán tomar las medidas apropiadas para impedir cualquier peligro (p. ej. medios de medición adecuados, seguros, limitación de tensión, corte protector, aislamiento etc.).
10. Para la conexión con dispositivos informáticos como un PC o un ordenador industrial, debe comprobarse que éstos cumplan los estándares IEC60950-1/EN60950-1 o IEC61010-1/EN 61010-1 válidos en cada caso.
11. A menos que esté permitido expresamente, no retire nunca la tapa ni componentes de la carcasa mientras el producto esté en servicio. Esto pone a descubierto los cables y componentes eléctricos y puede causar lesiones, fuego o daños en el producto.
12. Si un producto se instala en un lugar fijo, se deberá primero conectar el conductor de protección fijo con el conductor de protección del producto antes de hacer cualquier otra conexión. La instalación y la conexión deberán ser efectuadas por un electricista especializado.
13. En el caso de dispositivos fijos que no estén provistos de fusibles, interruptor automático ni otros mecanismos de seguridad similares, el circuito de alimentación debe estar protegido de modo que todas las personas que puedan acceder al producto, así como el producto mismo, estén a salvo de posibles daños.
14. Todo producto debe estar protegido contra sobretensión (debida p. ej. a una caída del rayo) mediante los correspondientes sistemas de protección. Si no, el personal que lo utilice quedará expuesto al peligro de choque eléctrico.
15. No debe introducirse en los orificios de la caja del aparato ningún objeto que no esté destinado a ello. Esto puede producir cortocircuitos en el producto y/o puede causar choques eléctricos, fuego o lesiones.
16. Salvo indicación contraria, los productos no están impermeabilizados (ver también el capítulo "Estados operativos y posiciones de funcionamiento", punto 1). Por eso es necesario tomar las medidas necesarias para evitar la entrada de líquidos. En caso contrario, existe peligro de choque eléctrico para el usuario o de daños en el producto, que también pueden redundar en peligro para las personas.
17. No utilice el producto en condiciones en las que pueda producirse o ya se hayan producido condensaciones sobre el producto o en el interior de éste, como p. ej. al desplazarlo de un lugar frío a otro caliente. La entrada de agua aumenta el riesgo de choque eléctrico.
18. Antes de la limpieza, desconecte por completo el producto de la alimentación de tensión (p. ej. red de alimentación o batería). Realice la limpieza de los aparatos con un paño suave, que no se deshilache. No utilice bajo ningún concepto productos de limpieza químicos como alcohol, acetona o diluyentes para lacas nitrocelulósicas.

Instrucciones de seguridad elementales

Funcionamiento

1. El uso del producto requiere instrucciones especiales y una alta concentración durante el manejo. Debe asegurarse que las personas que manejen el producto estén a la altura de los requerimientos necesarios en cuanto a aptitudes físicas, psíquicas y emocionales, ya que de otra manera no se pueden excluir lesiones o daños de objetos. El empresario u operador es responsable de seleccionar el personal usuario apto para el manejo del producto.
2. Antes de desplazar o transportar el producto, lea y tenga en cuenta el capítulo "Transporte".
3. Como con todo producto de fabricación industrial no puede quedar excluida en general la posibilidad de que se produzcan alergias provocadas por algunos materiales empleados —los llamados alérgenos (p. ej. el níquel)—. Si durante el manejo de productos Rohde & Schwarz se producen reacciones alérgicas, como p. ej. irritaciones cutáneas, estornudos continuos, enrojecimiento de la conjuntiva o dificultades respiratorias, debe avisarse inmediatamente a un médico para investigar las causas y evitar cualquier molestia o daño a la salud.
4. Antes de la manipulación mecánica y/o térmica o el desmontaje del producto, debe tenerse en cuenta imprescindiblemente el capítulo "Eliminación/protección del medio ambiente", punto 1.
5. Ciertos productos, como p. ej. las instalaciones de radiocomunicación RF, pueden a causa de su función natural, emitir una radiación electromagnética aumentada. Deben tomarse todas las medidas necesarias para la protección de las mujeres embarazadas. También las personas con marcapasos pueden correr peligro a causa de la radiación electromagnética. El empresario/operador tiene la obligación de evaluar y señalizar las áreas de trabajo en las que exista un riesgo elevado de exposición a radiaciones.
6. Tenga en cuenta que en caso de incendio pueden desprenderse del producto sustancias tóxicas (gases, líquidos etc.) que pueden generar daños a la salud. Por eso, en caso de incendio deben usarse medidas adecuadas, como p. ej. máscaras antigás e indumentaria de protección.
7. Los productos con láser están provistos de indicaciones de advertencia normalizadas en función de la clase de láser del que se trate. Los rayos láser pueden provocar daños de tipo biológico a causa de las propiedades de su radiación y debido a su concentración extrema de potencia electromagnética. En caso de que un producto Rohde & Schwarz contenga un producto láser (p. ej. un lector de CD/DVD), no debe usarse ninguna otra configuración o función aparte de las descritas en la documentación del producto, a fin de evitar lesiones (p. ej. debidas a irradiación láser).
8. Clases de compatibilidad electromagnética (conforme a EN 55011 / CISPR 11; y en analogía con EN 55022 / CISPR 22, EN 55032 / CISPR 32)
 - Aparato de clase A:
Aparato adecuado para su uso en todos los entornos excepto en los residenciales y en aquellos conectados directamente a una red de distribución de baja tensión que suministra corriente a edificios residenciales.
Nota: Los aparatos de clase A están destinados al uso en entornos industriales. Estos aparatos pueden causar perturbaciones radioeléctricas en entornos residenciales debido a posibles perturbaciones guiadas o radiadas. En este caso, se le podrá solicitar al operador que tome las medidas adecuadas para eliminar estas perturbaciones.
 - Aparato de clase B:
Aparato adecuado para su uso en entornos residenciales, así como en aquellos conectados directamente a una red de distribución de baja tensión que suministra corriente a edificios residenciales.

Instrucciones de seguridad elementales

Reparación y mantenimiento

1. El producto solamente debe ser abierto por personal especializado con autorización para ello. Antes de manipular el producto o abrirlo, es obligatorio desconectarlo de la tensión de alimentación, para evitar toda posibilidad de choque eléctrico.
2. El ajuste, el cambio de partes, el mantenimiento y la reparación deberán ser efectuadas solamente por electricistas autorizados por Rohde & Schwarz. Si se reponen partes con importancia para los aspectos de seguridad (p. ej. el enchufe, los transformadores o los fusibles), solamente podrán ser sustituidos por partes originales. Después de cada cambio de partes relevantes para la seguridad deberá realizarse un control de seguridad (control a primera vista, control del conductor de protección, medición de resistencia de aislamiento, medición de la corriente de fuga, control de funcionamiento). Con esto queda garantizada la seguridad del producto.

Baterías y acumuladores o celdas

Si no se siguen (o se siguen de modo insuficiente) las indicaciones en cuanto a las baterías y acumuladores o celdas, pueden producirse explosiones, incendios y/o lesiones graves con posible consecuencia de muerte. El manejo de baterías y acumuladores con electrolitos alcalinos (p. ej. celdas de litio) debe seguir el estándar EN 62133.

1. No deben desmontarse, abrirse ni triturarse las celdas.
2. Las celdas o baterías no deben someterse a calor ni fuego. Debe evitarse el almacenamiento a la luz directa del sol. Las celdas y baterías deben mantenerse limpias y secas. Limpiar las conexiones sucias con un paño seco y limpio.
3. Las celdas o baterías no deben cortocircuitarse. Es peligroso almacenar las celdas o baterías en estuches o cajones en cuyo interior puedan cortocircuitarse por contacto recíproco o por contacto con otros materiales conductores. No deben extraerse las celdas o baterías de sus embalajes originales hasta el momento en que vayan a utilizarse.
4. Las celdas o baterías no deben someterse a impactos mecánicos fuertes indebidos.
5. En caso de falta de estanqueidad de una celda, el líquido vertido no debe entrar en contacto con la piel ni los ojos. Si se produce contacto, lavar con agua abundante la zona afectada y avisar a un médico.
6. En caso de cambio o recarga inadecuados, las celdas o baterías que contienen electrolitos alcalinos (p. ej. las celdas de litio) pueden explotar. Para garantizar la seguridad del producto, las celdas o baterías solo deben ser sustituidas por el tipo Rohde & Schwarz correspondiente (ver lista de recambios).
7. Las baterías y celdas deben reciclarse y no deben tirarse a la basura doméstica. Las baterías o acumuladores que contienen plomo, mercurio o cadmio deben tratarse como residuos especiales. Respete en esta relación las normas nacionales de eliminación y reciclaje.

Transporte

1. El producto puede tener un peso elevado. Por eso es necesario desplazarlo o transportarlo con precaución y, si es necesario, usando un sistema de elevación adecuado (p. ej. una carretilla elevadora), a fin de evitar lesiones en la espalda u otros daños personales.

Instrucciones de seguridad elementales

2. Las asas instaladas en los productos sirven solamente de ayuda para el transporte del producto por personas. Por eso no está permitido utilizar las asas para la sujeción en o sobre medios de transporte como p. ej. grúas, carretillas elevadoras de horquilla, carros etc. Es responsabilidad suya fijar los productos de manera segura a los medios de transporte o elevación. Para evitar daños personales o daños en el producto, siga las instrucciones de seguridad del fabricante del medio de transporte o elevación utilizado.
3. Si se utiliza el producto dentro de un vehículo, recae de manera exclusiva en el conductor la responsabilidad de conducir el vehículo de manera segura y adecuada. El fabricante no asumirá ninguna responsabilidad por accidentes o colisiones. No utilice nunca el producto dentro de un vehículo en movimiento si esto pudiera distraer al conductor. Asegure el producto dentro del vehículo debidamente para evitar, en caso de un accidente, lesiones u otra clase de daños.

Eliminación/protección del medio ambiente

1. Los dispositivos marcados contienen una batería o un acumulador que no se debe desechar con los residuos domésticos sin clasificar, sino que debe ser recogido por separado. La eliminación se debe efectuar exclusivamente a través de un punto de recogida apropiado o del servicio de atención al cliente de Rohde & Schwarz.
2. Los dispositivos eléctricos usados no se deben desechar con los residuos domésticos sin clasificar, sino que deben ser recogidos por separado.
Rohde & Schwarz GmbH & Co.KG ha elaborado un concepto de eliminación de residuos y asume plenamente los deberes de recogida y eliminación para los fabricantes dentro de la UE. Para desechar el producto de manera respetuosa con el medio ambiente, dirijase a su servicio de atención al cliente de Rohde & Schwarz.
3. Si se trabaja de manera mecánica y/o térmica cualquier producto o componente más allá del funcionamiento previsto, pueden liberarse sustancias peligrosas (polvos con contenido de metales pesados como p. ej. plomo, berilio o níquel). Por eso el producto solo debe ser desmontado por personal especializado con formación adecuada. Un desmontaje inadecuado puede ocasionar daños para la salud. Se deben tener en cuenta las directivas nacionales referentes a la eliminación de residuos.
4. En caso de que durante el trato del producto se formen sustancias peligrosas o combustibles que deban tratarse como residuos especiales (p. ej. refrigerantes o aceites de motor con intervalos de cambio definidos), deben tenerse en cuenta las indicaciones de seguridad del fabricante de dichas sustancias y las normas regionales de eliminación de residuos. Tenga en cuenta también en caso necesario las indicaciones de seguridad especiales contenidas en la documentación del producto. La eliminación incorrecta de sustancias peligrosas o combustibles puede causar daños a la salud o daños al medio ambiente.

Se puede encontrar más información sobre la protección del medio ambiente en la página web de Rohde & Schwarz.

Quality management and environmental management

Certified Quality System
ISO 9001

Certified Environmental System
ISO 14001

Sehr geehrter Kunde,

Sie haben sich für den Kauf eines Rohde&Schwarz Produktes entschieden. Sie erhalten damit ein nach modernsten Fertigungsmethoden hergestelltes Produkt. Es wurde nach den Regeln unserer Qualitäts- und Umweltmanagementsysteme entwickelt, gefertigt und geprüft. Rohde&Schwarz ist unter anderem nach den Managementsystemen ISO9001 und ISO 14001 zertifiziert.

Der Umwelt verpflichtet

- Energie-effiziente, RoHS-konforme Produkte
- Kontinuierliche Weiterentwicklung nachhaltiger Umweltkonzepte
- ISO 14001-zertifiziertes Umweltmanagementsystem

Dear customer,

You have decided to buy a Rohde&Schwarz product. This product has been manufactured using the most advanced methods. It was developed, manufactured and tested in compliance with our quality management and environmental management systems. Rohde&Schwarz has been certified, for example, according to the ISO9001 and ISO 14001 management systems.

Environmental commitment

- Energy-efficient products
- Continuous improvement in environmental sustainability
- ISO 14001-certified environmental management system

Cher client,

Vous avez choisi d'acheter un produit Rohde&Schwarz. Vous disposez donc d'un produit fabriqué d'après les méthodes les plus avancées. Le développement, la fabrication et les tests de ce produit ont été effectués selon nos systèmes de management de qualité et de management environnemental. La société Rohde&Schwarz a été homologuée, entre autres, conformément aux systèmes de management ISO9001 et ISO 14001.

Engagement écologique

- Produits à efficience énergétique
- Amélioration continue de la durabilité environnementale
- Système de management environnemental certifié selon ISO 14001



Customer Support

Technical support – where and when you need it

For quick, expert help with any Rohde & Schwarz equipment, contact one of our Customer Support Centers. A team of highly qualified engineers provides telephone support and will work with you to find a solution to your query on any aspect of the operation, programming or applications of Rohde & Schwarz equipment.

Up-to-date information and upgrades

To keep your instrument up-to-date and to be informed about new application notes related to your instrument, please send an e-mail to the Customer Support Center stating your instrument and your wish. We will take care that you will get the right information.

Europe, Africa, Middle East

Phone +49 89 4129 12345
customersupport@rohde-schwarz.com

North America

Phone 1-888-TEST-RSA (1-888-837-8772)
customer.support@rsa.rohde-schwarz.com

Latin America

Phone +1-410-910-7988
customersupport.la@rohde-schwarz.com

Asia/Pacific

Phone +65 65 13 04 88
customersupport.asia@rohde-schwarz.com

China

Phone +86-800-810-8228 /
+86-400-650-5896
customersupport.china@rohde-schwarz.com



Operation of the R&S NRP-Z81/-Z85/-Z86 wideband power sensors on R&S NRP base unit

Dear Customer,

for proper operation of the R&S NRP-Z81/-Z85/-Z86 wideband power sensors on a R&S NRP, the right software is required for the base unit:

Main Program (Application)	≥ 5.01
Bootloader	≥ 5.01
Keyboard Controller	≥ 3.22

The revision numbers for the software components installed in the base unit can be displayed under menu item 'System Info', lines 'Main Program', 'Bootloader' and 'Keybd. Ctrl.'. The 'System Info' can be found in the 'System' menu.

Please note, that the statistics capabilities of the sensors are not yet supported by these revisions.

Table of Contents

1	Putting into Operation	1.1
	Unpacking the sensor	1.1
	Connecting the sensor	1.1
	Operation with the R&S NRP/NRP2 power meter	1.2
	Connecting the power sensor	1.2
	PC control	1.2
	Hardware and software requirements	1.2
	Operation via the R&S NRP-Z4 passive USB adapter	1.3
	Connecting the sensor to the DUT	1.4
	Operation via the Active USB Adapter R&S NRP-Z3	1.4
	Operation via the R&S NRP-Z5 Sensor Hub	1.5
	Equipment Supplied and Alternative Accessories	1.5
	Ports and LEDs	1.6
	Test Setup	1.7
	Troubleshooting	1.9
	Operation with other Rohde & Schwarz test instruments	1.10
	Hardware and software requirements	1.10

Figs.

Fig. 1-1	Displaying the total available power of a USB port.....	1.3
Fig. 1-2	Configuration with Passive USB Adapter R&S NRP-Z4	1.3
Fig. 1-3	Configuration with Active USB Adapter R&S NRP-Z3.....	1.4
Fig. 1-4	Changing the primary adapter	1.5
Fig. 1-5	Ports and LEDs on front panel.....	1.6
Fig. 1-6	Ports on rear panel	1.6
Fig. 1-7	Unlatching the <i>R&S Instrument</i> connector.....	1.7
Fig. 1-8	Typical test setup with R&S NRP-Z5 and PC	1.8
Fig. 1-9	Changing the view in Device Manager	1.9
Fig. 1-10	Identification of USB root hub on which R&S NRP-Z5 is operated	1.9
Fig. 1-11	Deactivation of <i>Selective Suspend</i> for a USB root hub	1.10

Tables

Table 1-1	RF connectors of R&S NRP-Z81/85/86 power sensors	1.1
-----------	--	-----

1 Putting into Operation

NOTICE Follow the instructions below precisely to prevent damage to the power sensor – particularly when you are putting it into operation for the first time.

Unpacking the sensor

Remove the sensor from its packing and check that nothing is missing. Inspect all items for damage. If you discover any damage, inform the carrier responsible immediately and keep the packing to support any claims for compensation.

It is also best to use the original packing if the sensor is to be shipped or transported at a later date.



The power sensor contains components which can be destroyed by electrostatic discharges. To prevent this happening, never touch the inner conductor of the RF connector and never open the power sensor.

Connecting the sensor

NOTICE To prevent EMI, the power sensor must never be operated with its enclosure wholly or partially removed. Only use shielded cables that meet the relevant EMC standards.

Never exceed the maximum RF power limit. Even brief overloads can destroy the power sensor.

Caused by their different frequency ranges, the R&S NRP-Z81/85/86 power sensors have different RF connectors. In this context, the following sections will refer to Table 1-1:

Table 1-1 RF connectors of R&S NRP-Z81/85/86 power sensors

Power sensor	Male connector	Matching female connector	Tightening torque
R&S NRP-Z81	N	N	1.36 Nm (12" lbs)
R&S NRP-Z85	2.92 mm	3.5 mm/2.92 mm/SMA	0.9 Nm (8" lbs)
R&S NRP-Z86	2.4 mm	2.4 mm/1.85 mm	

Operation with the R&S NRP/NRP2 power meter

Connecting the power sensor

The power sensor can be connected to the R&S NRP/NRP2 base unit when it is in operation. The multiple circular plug-in connector must be inserted, red marking upwards, into one of the R&S NRP/NRP2 base unit's sensor connectors. When the power sensor is connected, it is detected by the R&S NRP/NRP2 base unit and initialized.

See Table 1-1 for the type of male RF connector a certain power sensor has and which female connectors it mates with. Using light pressure, and keeping the male connector perpendicular, insert it into the female connector and tighten the locking nut (right-hand thread). In many cases, the RF connector only requires manual tightening. However, for maximal measurement accuracy, the RF connector must be tightened using a torque wrench with a nominal torque that corresponds with the tightening torque shown in Table 1-1.

PC control

Hardware and software requirements

The following requirements must be met if the power sensor is to be controlled by a PC via an interface adapter:

- The PC must have a USB port.
- Either Microsoft Windows XP (32 Bit), Microsoft Windows Vista (32 or 64 Bit), Microsoft Windows 7 (32 or 64 Bit), or x86 Linux (with kernel 2.6.8 oder more recent) must be installed as the operating system of the PC. 64-bit versions of Microsoft Windows XP are not supported. Operation with older versions of Microsoft Windows with USB support (especially Microsoft Windows 2000) is normally possible but cannot be guaranteed.
- The USB device drivers in the supplied *NRP Toolkit* software package must be installed.

If these requirements are met, the power sensor can be controlled using a suitable application program such as the *NrpFlashup* program contained in the Microsoft Windows version of the *NRP Toolkit* (includes the modules *Power Viewer*, *USB Terminal*, *Firmware Update* and *Update S-Parameters*).

When you insert the CD-ROM supplied with the R&S NRP power sensor, the *NRP Toolkit* is automatically installed on your PC. The rest of the procedure is self-explanatory.

The power sensor can be powered in two ways:

- *Self-powered* from a separate power supply via the Active USB Adapter R&S NRP-Z3 or the Sensor Hub R&S NRP-Z5.
- *Bus-powered* from the PC or a USB hub with its own power supply (*self-powered hub*) via the Active USB Adapter R&S NRP-Z3 or via the Passive USB Adapter R&S NRP-Z4.

As the power sensor is a *high-power device*, there is no guarantee that it can be powered from all types of laptop or notebook in the *bus-powered* mode. To be sure, you should determine the current at the USB connectors beforehand:



- In the Windows™ start menu, select **Settings – Control Panel**
- Select the **System** icon
- Select the **Hardware** tab
- By clicking on the button with that name, start the **Device Manager**
- Open **USB Controller** (all USB controllers, hubs and USB devices are listed here)
- Double-click on **USB Root Hub** or select **Properties** in the context menu (use the right-hand mouse button)
- Select the **Power** tab (Fig. 1-1). If the hub is self-powered and the total power available is, as indicated by **Hub Information**, 500 mA per port, high-power devices can be connected.

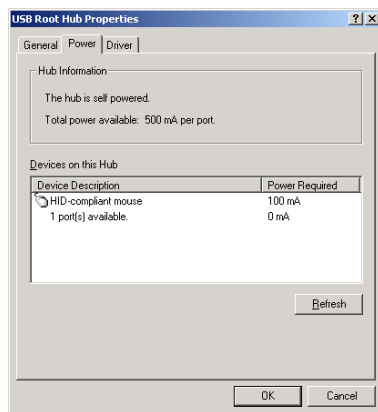

Fig. 1-1 Displaying the total available power of a USB port

If you have any doubts, ask the manufacturer if the USB port on your laptop or notebook can handle *high-power devices*.

Operation via the R&S NRP-Z4 passive USB adapter

Fig. 1-2 is a schematic of the measurement setup. The order in which the cables are connected is not critical.

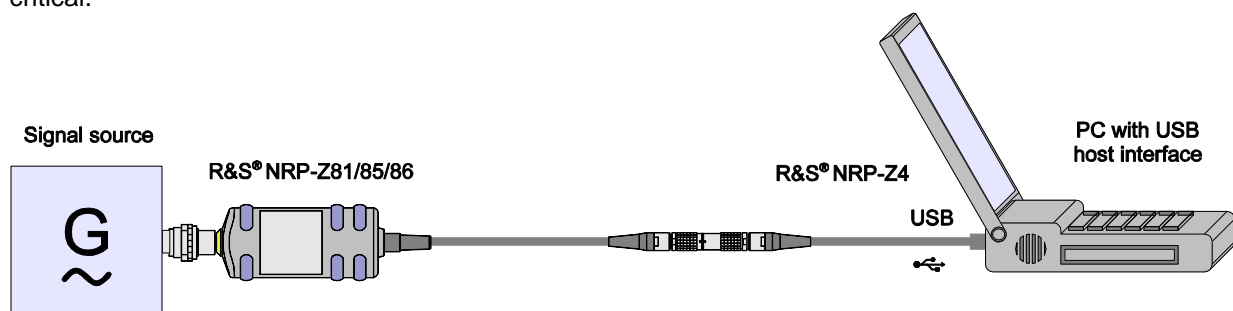

Fig. 1-2 Configuration with Passive USB Adapter R&S NRP-Z4

Connecting the sensor to the DUT

See Table 1-1 for the type of male RF connector a certain power sensor has and which female connectors it mates with. Using light pressure, and keeping the male connector perpendicular, insert it into the female connector and tighten the locking nut (right-hand thread). In many cases, the RF connector only requires manual tightening. However, for maximal measurement accuracy, the RF connector must be tightened using a torque wrench with a nominal torque that corresponds with the tightening torque shown in Table 1-1.

Operation via the Active USB Adapter R&S NRP-Z3

Fig. 1-3 shows the configuration with the Active USB Adapter R&S NRP-Z3, which also makes it possible to feed in a trigger signal for the *Timeslot* and *Trace* modes. The order in which the cables are connected is not critical.

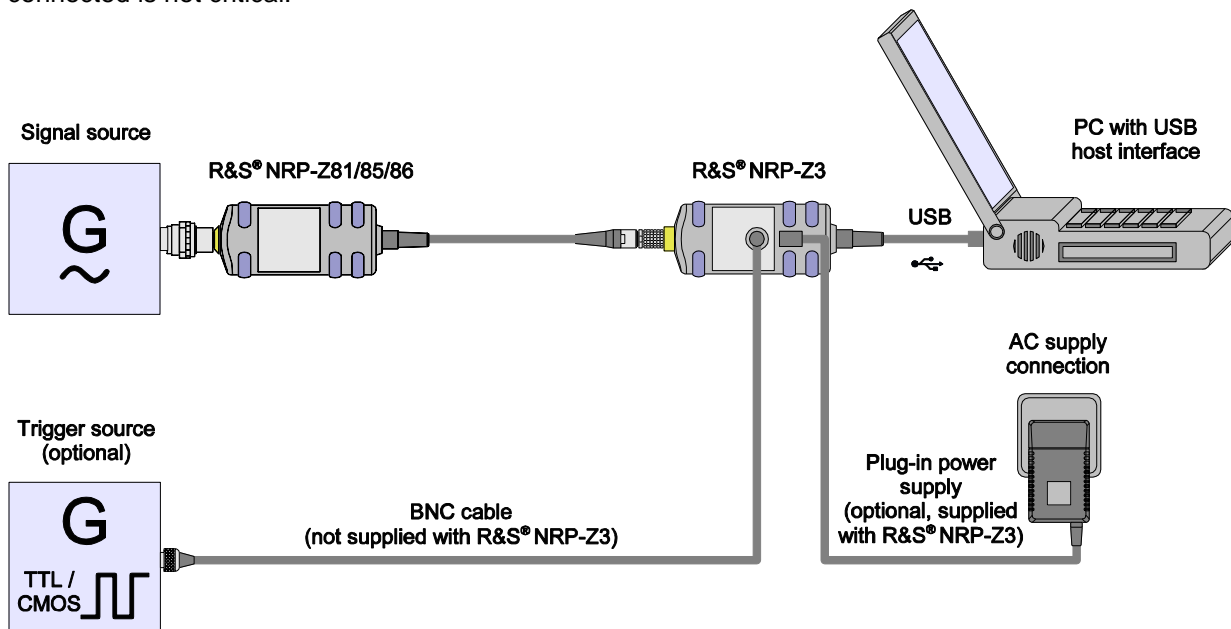

Fig. 1-3 Configuration with Active USB Adapter R&S NRP-Z3

The plug-in power supply for the R&S NRP-Z3 can be powered from a single-phase AC source with a nominal voltage range of 100 V to 240 V and a nominal frequency between 50 Hz and 60 Hz. The plug-in power supply autoselects to the applied AC voltage. No manual voltage selection is required.

The plug-in power supply comes with four primary adapters for Europe, the UK, the USA and Australia. No tools of any kind are required to change the primary adapter. The adapter is pulled out manually and another adapter inserted until it locks (Fig. 1-4).

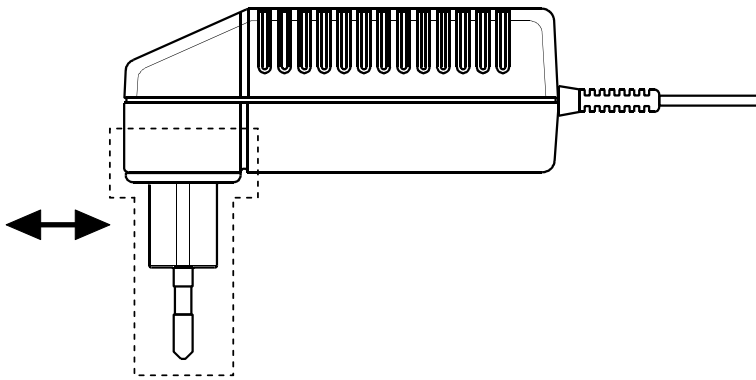

Fig. 1-4 Changing the primary adapter

The plug-in power supply is short-circuit-proof and has an internal fuse. It is not possible to replace this fuse or open the plug-in power supply.

NOTICE *The plug-in power supply is not intended for outdoor use.*

Keep within the temperature range of 0°C to 50°C.

If there is any condensation on the plug-in power supply, dry it off before connecting it to the AC supply.

Operation via the R&S NRP-Z5 Sensor Hub

The R&S NRP-Z5 sensor hub allows up to four power sensors to be operated on one PC. It combines the following functions:

- 4-port USB 2.0 hub
- Power supply
- Through-wired trigger bus
- Trigger input and trigger output via BNC sockets

Equipment Supplied and Alternative Accessories

The following equipment is supplied:

- Sensor hub
- External power supply
- Power cable
- USB cable

Instead of the supplied, 2 m long USB cable, it is possible to use any other USB-2.0-certified cable (USB connector type A to USB connector type B) with a maximum length of 5 m. If a locking connection is required at the instrument end, it is also possible to use the passive R&S NRP-Z4 interface adapter instead of a standard USB cable.

As an alternative to the supplied external power supply, power can also be supplied using a DC voltage source with an output voltage of 12 V to 24 V and a power output of at least 24 W. Make sure that the polarity is correct (positive pole inside, negative pole outside). The alternative DC voltage source must be in the same building as the R&S NRP-Z5 and must be connected to the latter via a cable with a maximum length of 30 m. Power must not be supplied from a low-voltage supply system.

The supplied external power supply is short-circuit-proof and is also protected by an internal fuse. It is not possible to change the fuse or open the unit.

NOTICE *The external power supply is not intended for outdoor use.*

Keep within the temperature range of 0°C to 50°C.

If there is any condensation on the external power supply, dry it off before connecting it to the AC supply.

Ports and LEDs

The power sensors are connected to the front panel of the R&S NRP-Z5. The ports and LEDs on the front panel of the R&S NRP-Z5 are shown in Fig. 1-5.

- 1–4 Sockets for connecting the power sensors
- 5–8 Green LEDs for indicating normal operation
- 9–12 Yellow LEDs for indicating faults

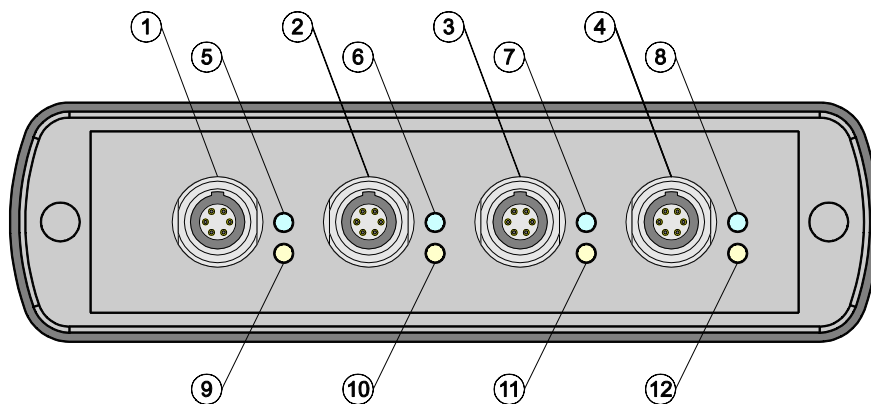

Fig. 1-5 Ports and LEDs on front panel

On the rear panel are the ports for power supply, USB host, trigger input and trigger output. The ports on the rear panel are shown in Fig. 1-6.

- 1 Trigger output (BNC socket)
- 2 Trigger input (BNC socket)
- 3 Plug allowing connection to Rohde & Schwarz measuring instruments (via R&S NRP-Z2) or to a PC (via R&S NRP-Z4)
- 4 USB socket (type B) for connection to the USB host (PC or Rohde & Schwarz measuring instrument without sensor socket)
- 5 Power supply socket (supplied external power supply unit or alternative power supply (12 V to 24 V/24 W))

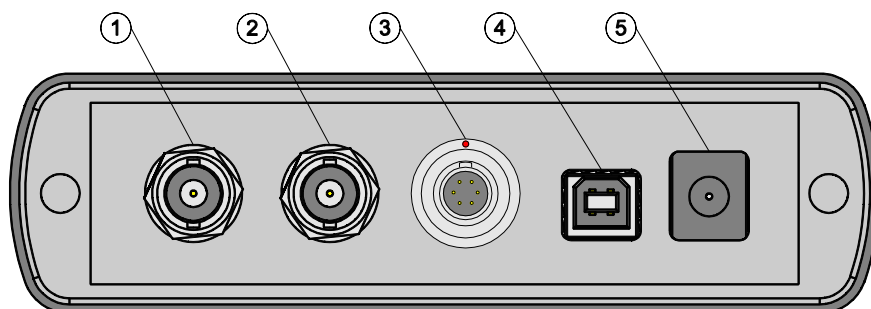
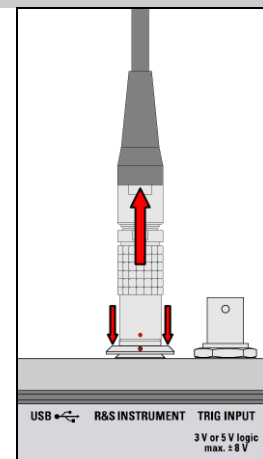

Fig. 1-6 Ports on rear panel



Unlatch the R&S Instrument connector on the rear panel by pressing down the unlatching ring of the built-in plug and pulling off the cable jack at the same time (Fig. 1-7).

Fig. 1-7 Unlatching the R&S Instrument connector



Test Setup

Fig. 1-8 shows a typical test setup:

- 1 R&S NRP-Z5 sensor hub
- 2 External power supply unit (supplied)
- 3 Power cable (supplied)
- 4 AC power supply
- 5 USB cable (supplied)
- 6 PC with USB host port
- 7, 8 BNC cable (optional, not supplied)
- 9 Trigger source (optional)
- 10 Triggered device (optional)
- 11-14 R&S NRP-Zxx power sensors (one to four sensors)
- 15 Signal source

The sequence in which the cables are connected is not important.

As already mentioned in section *Ports and LEDs*, the R&S NRP-Z4 passive interface adapter can also be used as an alternative to a standard USB cable for connecting to the PC. This adapter is connected to the *R&S Instrument* port. Simultaneous operation at two USB hosts is not possible as the USB host connected to the *R&S Instrument* port always has priority.

It is possible to cascade several R&S NRP-Z5 sensor hubs by connecting the *R&S Instrument* port of an R&S NRP-Z5 to one of the sensor ports of another R&S NRP-Z5. However, external triggering and the use of the *Trigger Master* function are then not possible. Instead, it is recommended to connect all R&S NRP-Z5 hubs individually to the USB host or to an interposed USB hub, and to feed the external trigger signal to all R&S NRP-Z5 hubs via their trigger inputs; or to forward the external trigger signal from the trigger output of the R&S NRP-Z5 to which the *Trigger Master* is connected to the trigger inputs of the other R&S NRP-Z5 hubs.

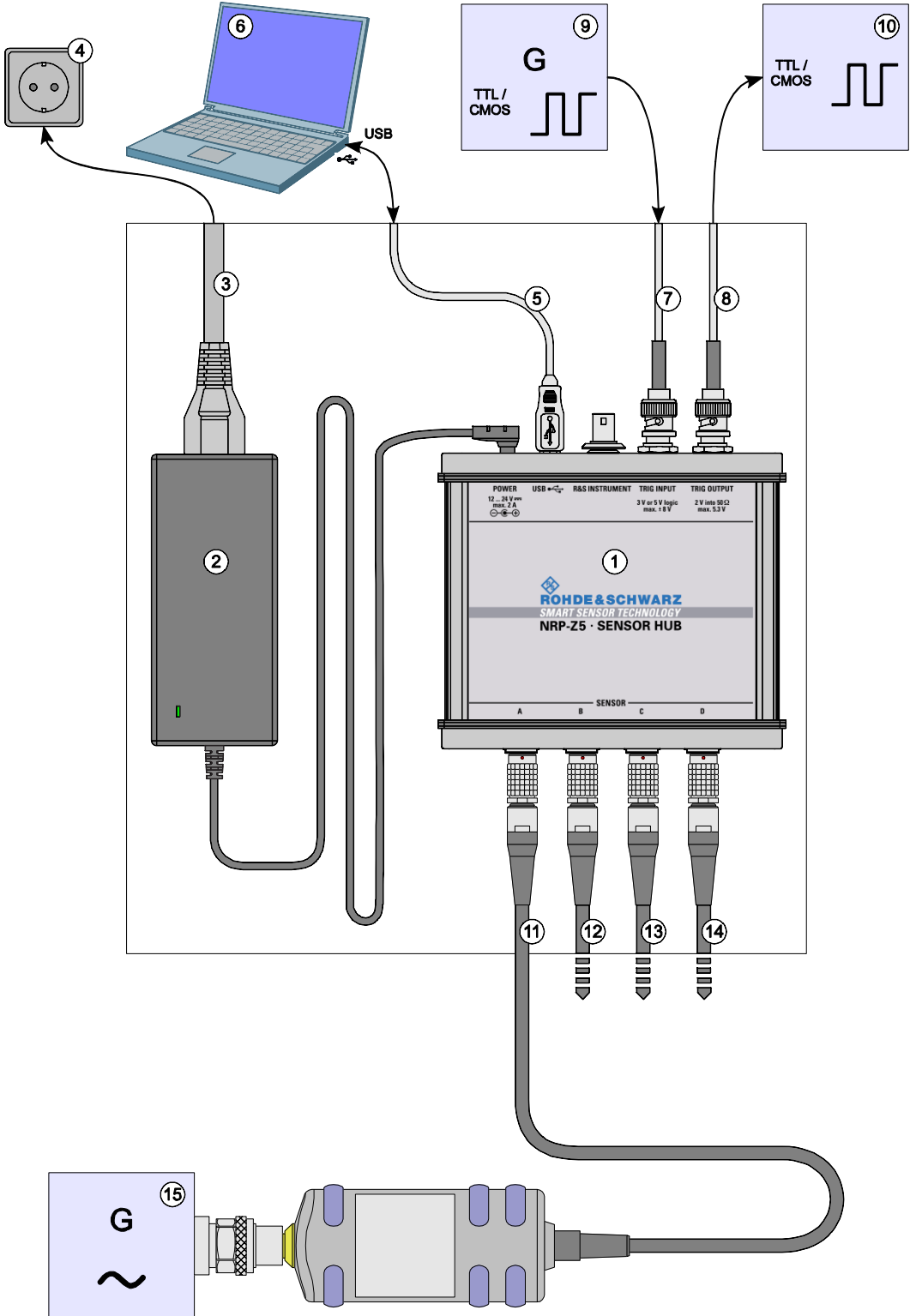

Fig. 1-8 Typical test setup with R&S NRP-Z5 and PC

Troubleshooting

A frequent problem, especially in the case of operation under Microsoft Windows XP, is that the R&S NRP-Z5 fails to respond after a power sensor connected to the R&S NRP-Z5 is disconnected and reconnected. It is then necessary to restart the PC.

This problem is not specific to the R&S NRP-Z5, but occurs with all USB hubs. You can try to eliminate the problem by switching off the *Selective Suspend* for the USB port of the PC on which the R&S NRP-Z5 is operated. The following step-by-step description is based on an English version of Windows XP:

1. Connect the R&S NRP-Z5 and put it into operation. Connect at least one power sensor.
2. Start the Device Manager and change the view by selecting **View - Devices by connection** (Fig. 1-9).

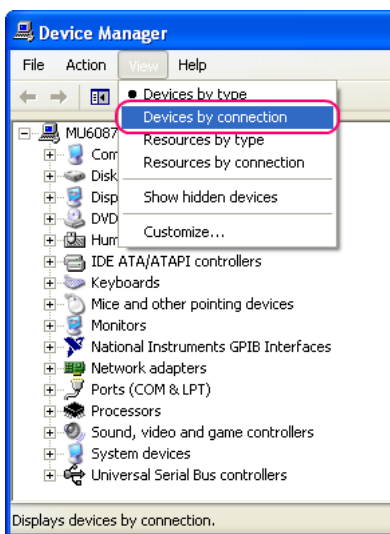

Fig. 1-9 Changing the view in Device Manager

3. Now identify the USB root hub on which the R&S NRP-Z5 is operated. To do so, expand the hierarchical display of the PC components, as shown in Fig. 1-10. Under **PCI bus**, find the USB host controller to whose root hub the R&S NRP-Z5 is connected. The R&S NRP-Z5 is shown as the **Generic USB Hub**. It can be distinguished from other USB hubs by the power sensor connected to it.

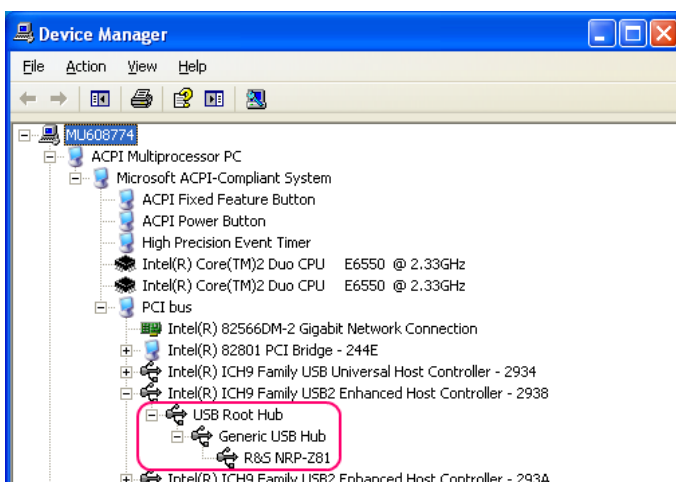

Fig. 1-10 Identification of USB root hub on which R&S NRP-Z5 is operated

4. Double-clicking **USB Root Hub** opens the **USB Root Hub Properties** dialog box. Select the Power Management tab. Remove the check mark next to **Allow the computer to turn off this device to save power** and confirm this with **OK**.

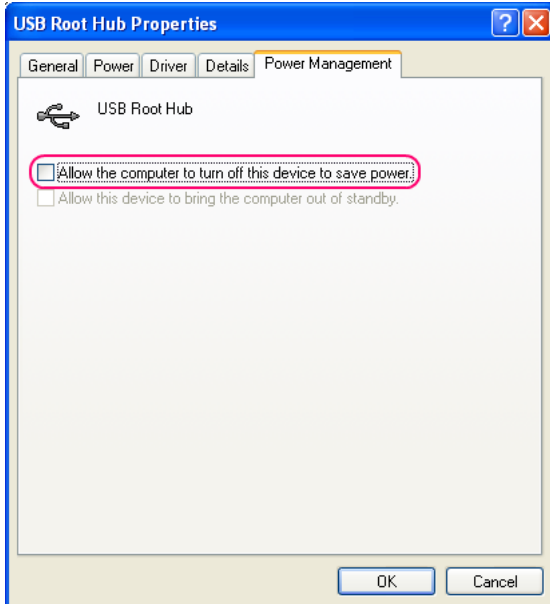

Fig. 1-11 Deactivation of *Selective Suspend* for a USB root hub

Operation with other R&S test instruments

Hardware and software requirements

Many Rohde & Schwarz test instruments allow power measurements using power sensors of the R&S NRP-Zxx series. The power sensors are generally connected to the USB ports of the test instrument via one of the two interface adapters, R&S NRP-Z3 or R&S NRP-Z4, or the Sensor Hub R&S NRP-Z5. On some instruments, such as the R&S SMU signal generator, there is also an R&S NRP sensor connector available for a direct connection. The R&S NRP-Z5 can be hooked up to this connector via an extension cable R&S NRP-Z2 (Model .03, .05, or .15). For that purpose, the *R&S Instrument* connector of the R&S NRP-Z5 is used.

Table of Contents

2	Virtual Power Meter	2.1
	Overview.....	2.1
	Menus	2.3

Figs.

Fig. 2-1 **Power Viewer** virtual power meter2.1

Tables

Table 2-1 Virtual power meter keys2.2
Table 2-2 Virtual power meter entry fields2.2

2 Virtual Power Meter

You will find the **NrpFlashup** program for controlling sensors with a PC under Windows™ on the CD-ROM that accompanies the sensor. The program comprises several modules which can be started centrally via the Windows™ start-menu entry **NRP Toolkit**.

This section describes the **Power Viewer** program module. This is a virtual power meter which only uses a cut-down set of the sensor's functions. This means that after an extremely brief familiarization period, the user can measure the average power of modulated signals.

The other modules in **NrpFlashup** are described in Chapter 3 of the operating manual (**Terminal** and **Update S-Parameters** modules) or in the service manual (**Firmware Update** module).

Overview

Start the virtual power meter using the **NRP Toolkit – Power Viewer** start-menu entry. The **Power Viewer** program window is displayed (Fig. 2-1).

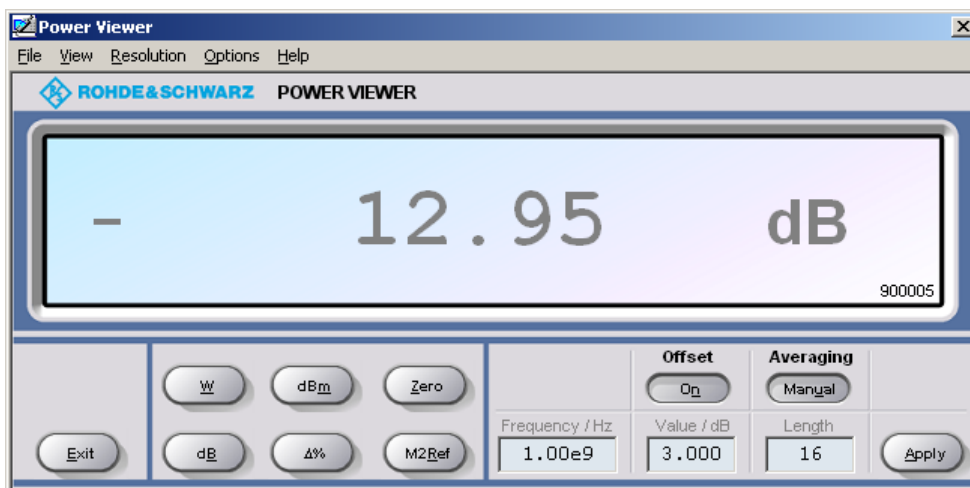

Fig. 2-1 **Power Viewer** – virtual power meter

The result display occupies most of the program window. The result, unit and additional sensor status information are displayed. The serial number of the sensor is displayed in the bottom right. The program window also contains animated buttons and entry fields (see Table 2-1 and Table 2-2).

Table 2-1 Virtual power meter keys

Button	Function	Key combination
Exit	Terminates the program. The current settings are saved and recalled the next time the program is started.	Alt + E
W	Selects Watt as the display unit.	Alt + W
dBm	Selects dBm as the display unit.	Alt + M
Zero	Zeroes the sensor.	Alt + Z
dB	Selects dB as the display unit. This is the log of the ratio of the measured value to the reference value.	Alt + B
Δ%	Selects % as the display unit. The difference between the measured value and the reference value is expressed as a percentage.	Alt + %
M2Ref	Makes the current measured value the reference value for the relative display units dB and %.	Alt + R
Offset On/Off	Turns the offset correction for the sensor on or off. If the offset correction is Off, the Offset/dB entry field has a grey background.	Alt + N
Averaging Man/Auto	Turns auto-averaging on or off. When auto-averaging is on, the Length entry field has a grey background; the current averaging factor is displayed.	Alt + T
Apply	Accepts edited numerical values in the Frequency/Hz , Value/dB and Length entry fields and transfers them to the sensor.	Alt + A or Enter key

Table 2-2 Virtual power meter entry fields

Entry field	Function
Frequency/Hz	Frequency of the RF carrier in Hertz.
Value/dB	Attenuation in dB of the twoport connected to the sensor. The valid range is -100 to 100. The offset correction must be activated beforehand with the Offset On/Off button if this entry field is to be edited.
Length	Length of the averaging filter (= averaging factor). The valid range is 1 to 65536. Averaging must be set to manual with the Averaging Man/Auto button if this entry field is to be edited.

Scientific notation can also be used for the entry fields. If an invalid entry is made, an error message is output. An edited numerical value will not be transferred to the sensor unless you use the **Apply** button or the Enter key to terminate the entry.

Menus

The menu bar can be used to call less frequently used functions.

File **Start Log ...** Opens a file-selection dialog to specify the path and name of the log file. Clicking the **Save** button starts the recording. All displayed values are written line-by-line to the log file with the date (format: YY/MM/DD) and time (format: hh:mm:ss.ms). Example:
-22.51 dBm (03/02/25 15:37:25.310)

Stop Log Ends the log-file recording.

View **Display Refresh Rate** Opens a dialog box to adjust the display refresh rate. The time in milliseconds between two refresh operations is entered. The default setting is 200 ms.

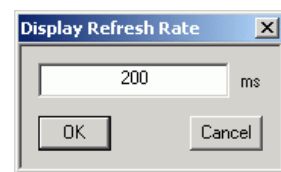

Colours Opens a dialog box to select the background colour for

- the result,
- the unit,
- the text in the number fields or
- the key labelling.

**Result
Unit
Edit
Button**

Resolution For setting the result resolution. If auto-averaging has been selected, a higher resolution leads to a greater averaging factor, which means a longer result settling time.

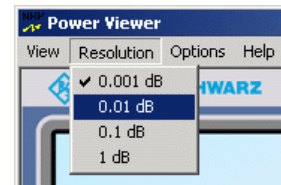

Options **Read Sensor Status ...** Reads the current sensor status. A parameter list is output.

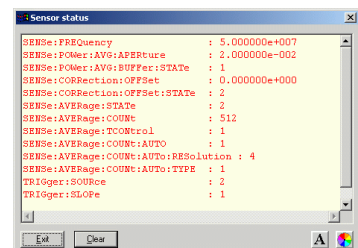

Read Error Queue ... Reads the error queue. All the error messages that have been issued since the last call are read line-by-line. A tick before this menu entry indicates that an error has occurred.

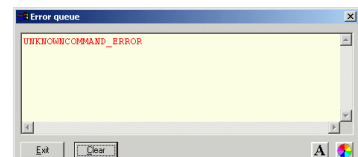

Simulation ...

For trying out the functions of the virtual power meter without actually connecting a sensor. The display alternates between **Measurement Value 1 & Measurement Value 2** with a period given by **Interval**. Simulation can be activated immediately with the **Activate** check box.

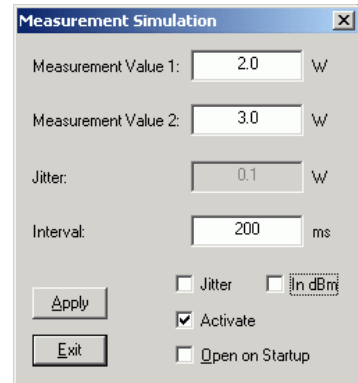

Reset Sensor

Initializes the sensor. Any previous zeroing remains valid.

Help

Contents

Opens the table of contents for the online-help facility.

About

Displays information about the program version used, etc.

Table of Contents

3	Manual Operation	3.1
	Program module “Terminal”	3.1
	Main control elements.....	3.1
	Menus	3.3
	Program module “Firmware Update”	3.6
	Program module “Update S-Parameters”	3.6
	Fundamentals	3.6
	Procedure	3.9

Figs.

Fig. 3-1 Sending commands using the **Input** field3.1
Fig. 3-2 Sending commands using command files3.2
Fig. 3-3 Dialog window for loading an s-parameter table.....3.9
Fig. 3-4 Dialog window for loading the backup file of a calibration data set3.10
Fig. 3-5 Subsequently changing the default behaviour of the s-parameter correction3.11

Tables

Table 3-1 Buttons assigned to the **Input** field3.2
Table 3-2 Buttons assigned to the **Command File** field3.2
Table 3-3 Buttons assigned to the **Output** field3.3
Table 3-4 Uncertainties of the s-parameter test system (example)3.7
Table 3-5 Interpolated uncertainties of measurement frequencies for s-parameters (example)3.7

3 Manual Operation

The previous section describes the Power Viewer program module supplied with the instrument. This module simplifies the most frequently used function of a power meter – measuring the average power of an RF signal of almost any modulation. Other program modules are also part of the supplied equipment and can be selected in the Start menu:

- **Power Viewer:** A detailed description of this virtual power meter module is provided in section 2.
- **Terminal:** Program module for sending commands and command sequences to the sensor and for displaying measurement results, status information and other data from the sensor
- **Firmware Update:** Program module for updating the sensor firmware
- **Update S-Parameters:** Program module for loading an s-parameter table into the sensor

Program module "Terminal"

Main control elements

With the USB terminal, commands and command sequences can be sent to the sensor in two different ways:

- Commands are entered in the **Input** field (Fig. 3-1). Consecutive commands can be entered as separate lines, one below the other. The buttons associated with the **Input** field are described in Table 3-1.
- Commands or command sequences are stored in *command files*. Command files are created with a text editor, for instance, and then stored. They can be called as often as required (Fig. 3-2). The buttons of the **Command File** field are described in Table 3-2.

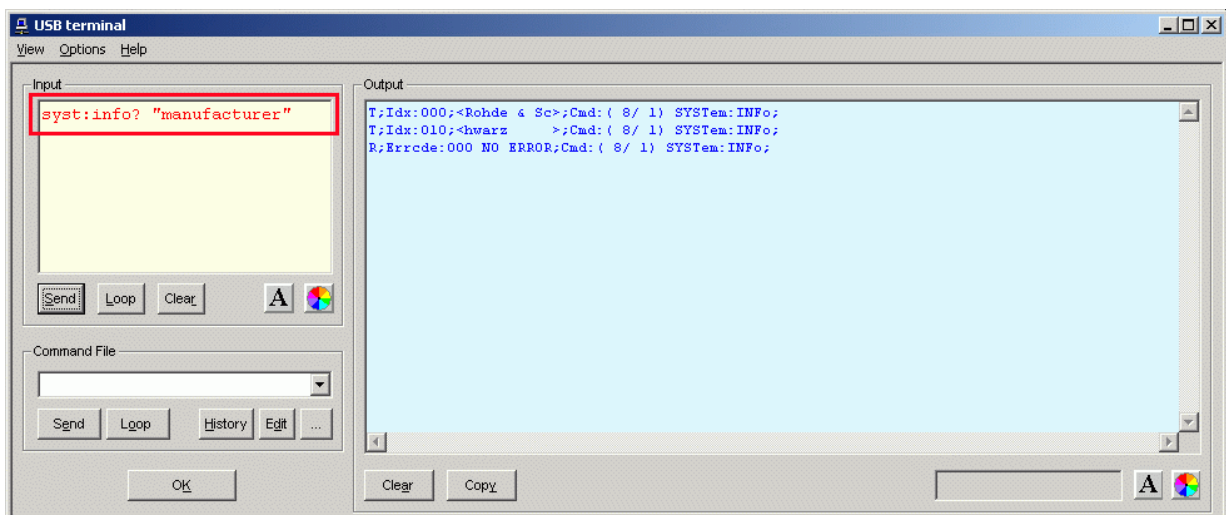

Fig. 3-1 Sending commands using the **Input** field

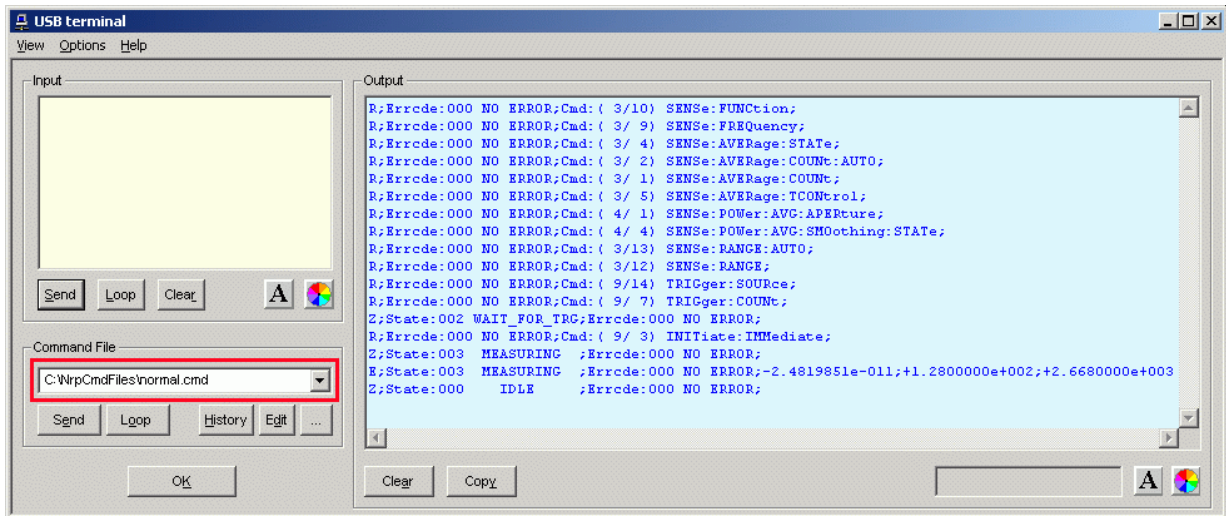

Fig. 3-2 Sending commands using command files

Table 3-1 Buttons assigned to the **Input** field

Button	Function	Key combination
Send	Sends the content of the Input entry field to the sensor.	Alt + S
Loop	With Loop the command or command sequence is cyclically sent. Pressing the button again terminates the cyclic transmission. The repetition rate is set in a dialog window that can be opened with View - Loop...	Alt + L
Clear	Clears the content of the Input field.	Alt + R
Font key	Opens a dialog window where the font for the Input field can be selected.	
Colour key	Opens a dialog window where the background colour of the Input field can be selected.	

Table 3-2 Buttons assigned to the **Command File** field

Button	Function	Key combination
Send	Sends the content of the command file to the sensor.	Alt + E
Loop	With Loop the command or command sequence is cyclically sent. Pressing the button again terminates the cyclic transmission. The repetition rate is set in a dialog window that can be opened with View - Loop...	Alt + O
History	Opens a window for editing the command file name in the Command File field.	Alt + H
Edit	Opens the selected command file in the Windows™ text editor.	Alt + D
...	Opens a file opening dialog for selecting the command file.	

A command line starting with a tab, a blank or a special character is considered a comment and not forwarded to the sensor.

Measurement results, parameters and status information returned by the sensor are displayed in the **Output** field.

Table 3-3 Buttons assigned to the **Output** field

Button	Function	Key combination
Clear	Clears the content of the Output field	Alt + A
Copy	Copies the content of the Output field to the clipboard. (Another possibility: mark the desired information in the output window with the mouse cursor, press the right mouse key or Ctrl+C and then copy the selected text to the clipboard using the menu item Copy in the opened context menu.)	Alt + Y
Font button	Opens a dialog window where the font for the Output field can be selected.	
Colour button	Opens a dialog window where the background colour of the Output field can be selected.	

Close the USB terminal with OK.

Menus

View Post Filter ... Opens the **Output Postfilter** dialog window where the lines stored in the input buffer can be filtered according to different criteria.

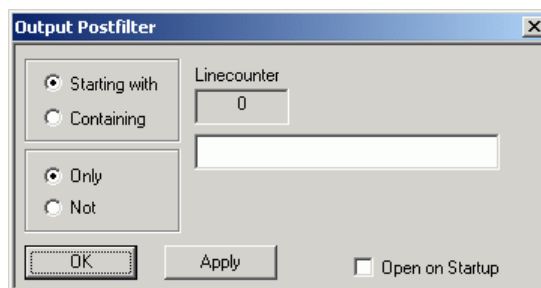

Filter criteria:

Only + Starting with: Only lines starting with the entered character string are displayed.

Not + Starting with: Only lines not starting with the entered character string are displayed.

Only + Containing: Only lines containing the entered character string are displayed.

Not + Containing: Only lines not containing the entered character string are displayed.

Lines not matching the specific filter criterion are blanked but not cleared.

Filtering is started with **Apply**. The number of lines matching the filter criterion is displayed in the **Linecounter** field. If **Open on startup** is active, the **Output Postfilter** dialog is automatically opened when the terminal is started. The dialog window is closed with **OK**.

Response Time ...

Opens the **Response time** dialog window where the response time of the sensor can be set.

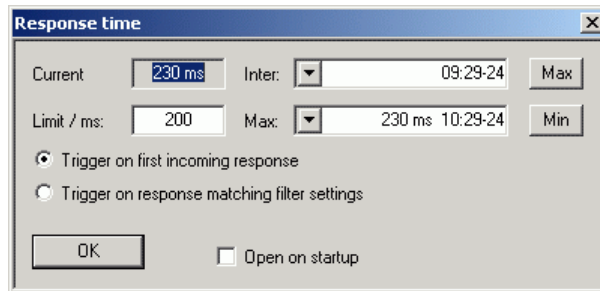

Current indicates the time elapsed between dispatch of the last command and receipt of an acknowledgement from the sensor. When the **Max** button is clicked, the response times exceeding the value in the **limit / ms** field are recorded. When the **Min** button is clicked, the response times within the value in the **limit / ms** field are recorded.

If **Trigger on first incoming response** is active, the time measurement is terminated as soon as the first response arrives after a command is sent. If **Trigger on response matching filter settings** is active, the time measurement is terminated as soon as the first response matching the filter criterion in the **Output Postfilter** dialog window is received.

If **Open on startup** is active, the **Response Time** dialog is automatically displayed when the Terminal module is started. The dialog window is closed with **OK**.

Loop ...

Opens the **Loop controls** dialog window where the cyclic transfer of commands and command sequences can be controlled.

In the **Delay / ms** field, the time interval for the cyclic transfer is specified in milliseconds.

The number of completed transfer cycles is displayed in the **Counter** field. If **Open on startup** is active, the **Response time** dialog is automatically opened when the Terminal module is started. The dialog window is closed with **OK**.

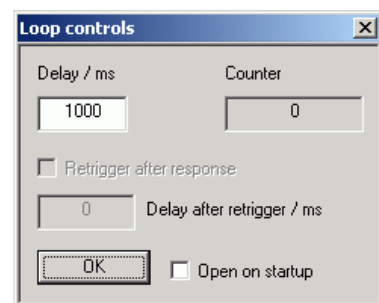

Options	Protocol Mode	In this mode, a time stamp is added to each response block.
	Hex Mode	In this mode, the response blocks from the sensor are displayed in hexadecimal format.
	Auto Delete	With this option active, the Output field is automatically cleared when the Send button is pressed.
	Auto Scroll	With this option active, older items in the Output field are automatically shifted upward and off the display if space is required for new values.
	LF at EOT	With this option active, a line feed is appended to each response block from the sensor.
	Delete on Start	With this option active, the Output field is automatically cleared when the Terminal module is started.
	Send as Hex	With this option active, the text in the Input field is interpreted as a hexadecimal character sequence.
	Advanced ...	Opens a dialog window where the buffer size for the Output field can be set.

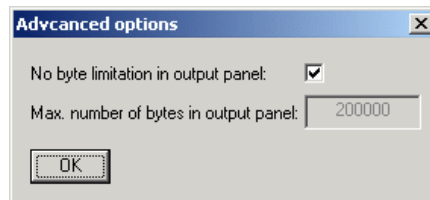
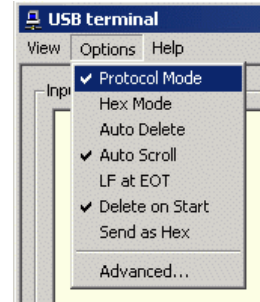

Help	Contents	Opens the table of contents for the online help.
	About	Displays information about the program version, etc.

Program module “Firmware Update”

A detailed description of the program module for firmware updates is provided in the Service Manual.

Program module “Update S-Parameters”

Fundamentals

With the power sensor R&S NRP-Z81/85/86, the influence of any twoport – e. g. an adapter – between the signal source and the sensor input can be considered, allowing the power P actually delivered by the signal source to be calculated.

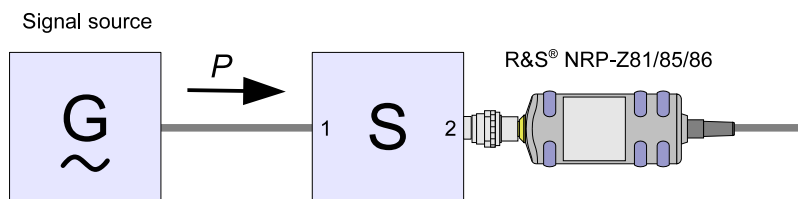

Fig. 3-1 Operation with twoport between signal source and sensor input

A precondition is that a complete set of s-parameter data of the twoport is available in the frequency range in question. The set of calibration data of the sensor therefore includes a table with up to 1000 measurement frequencies. The real and the imaginary part as well as the uncertainty of the s-parameters s_{11} , s_{12} , s_{21} and s_{22} are stored for each frequency.

The measurement frequencies in the s-parameter table can be selected independent of the calibration frequencies of the sensor, allowing the twoport frequency range of interest to be optimally covered. The real and the imaginary parts between these measurement frequencies are linearly interpolated. Below the first and above the last measurement frequency, the values of the first and the last measurement frequency are used, respectively.

The NrpFlashup program (menu item **Update S-Parameters**) is used for loading an s-parameter table. To ensure compatibility with a great number of network analyzers, NrpFlashup can process measurement data files in S2P format. All standard frequency units (Hz, kHz, MHz, GHz) and display formats (real and imaginary part, linear magnitude and phase, magnitude in dB and phase) are supported. The only restriction is that a reference impedance of $50\ \Omega$ must be used for the s-parameters. Additional noise parameters in the measurement data file are ignored.

Structure of the S2P measurement data file:

1. The *option line* has the following format (square brackets indicate that the enclosed content is optional):

```
# [<frequency unit>] [<parameter>] [<format>] [<R n>]
```

identifies the *option line*.

The <frequency unit> may be Hz, kHz, MHz or GHz. If a frequency unit is not specified, GHz is implicitly assumed.

If a parameter is specified, S must be used in <parameter> for s-parameter files. If a parameter is not specified, S is implicitly assumed.

The <format> may be MA (linear magnitude and phase in degree), DB (magnitude in dB, phase in degree) or RI (real and imaginary part). If a format is not specified, MA is implicitly assumed.

R is optional and followed by the reference impedance in Ω . If an entry is made for R, R50 must be specified. If no entry is made, R50 is implicitly assumed.

The *option line* should therefore read:

[HZ | KHZ | MHZ | GHZ] [S] [MA | DB | RI] [R 50]

2. The measurement frequencies in ascending order are specified as follows:

$$f_i \quad s_{11}(f_i) \quad s_{21}(f_i) \quad s_{12}(f_i) \quad s_{22}(f_i),$$

where $s_{jk}(f_i)$ is the display format as specified in the *option line*:

$$\left| s_{jk}(f_i) \right| \quad \arg s_{jk}(f_i) \quad \text{(display format for linear magnitude and phase in degree) or}$$

$$20 \cdot \lg \left| s_{jk}(f_i) \right| \quad \arg s_{jk}(f_i) \quad \text{(display format for magnitude in dB and phase in degree)}$$

$$\operatorname{Re} \left[s_{jk}(f_i) \right] \quad \operatorname{Im} \left[s_{jk}(f_i) \right] \quad \text{(display format for real and imaginary part)}$$

3. Comments: Any line starting with an exclamation mark (!) is interpreted as a comment line.

To characterize the measurement uncertainty of the s-parameter test system, another data file can optionally be created. Without this file, the measurement uncertainty cannot be correctly calculated in the sensor. The syntax of the uncertainty data file is similar to that of the S2P data file but U is specified as <Parameter> in the *option line* so that the *option line* reads # Hz U for frequencies in Hz.

The measurement frequencies must not be identical to those of the S2P measurement data files. In most cases a few entries will be sufficient to characterize the measurement uncertainty of the s-parameter test system. An s-parameter uncertainty as high as that of the neighbouring measurement frequencies of the uncertainty data file is then selected. If different values are available, the higher one is chosen. This is illustrated in the example below:

Table 3-4 Uncertainties of the s-parameter test system (example)

f in GHz	unc [$s_{ik}(f)$]
0.1	0.01
1.0	0.01
1.1	0.005
10.0	0.005
10.1	0.01
40.0	0.01

Table 3-5 Interpolated uncertainties of measurement frequencies for s-parameters (example)

f in GHz	unc [$s_{ik}(f)$]
0.9	0.01
0.95	0.01
1.0	0.01
1.05	0.01
1.1	0.005
1.15	0.005
1.2	0.005

At 1.05 GHz, the higher uncertainty of the two adjacent 1.0 GHz and 1.1 GHz measurement frequencies is entered in the s-parameter table. If an uncertainty of 0.005 is desired for all frequencies above 1.0 GHz, the first measurement frequency in the uncertainty data file must be above 1.0 GHz, e.g. 1.000001 GHz.

Structure of the uncertainty data file (square brackets indicate that the enclosed content is optional):

1. The *option line* has the following format:

[<frequency unit>] <parameter> [<format>] [<R n>]

identifies the *option line*.

The <frequency unit> may be Hz, kHz, MHz or GHz. If a frequency unit is not specified, GHz is implicitly assumed.

U must be specified for <parameter> in uncertainty data files. If a parameter is not specified, S is implicitly assumed and as a result an error message is triggered.

<format> is ignored in uncertainty measurement files; the entry is therefore irrelevant.

R is optional and followed by the reference impedance in Ω . If an entry is made for R, R50 must be specified. If no entry is made, R50 is implicitly assumed.

The *option line* should therefore read:

[HZ | KHZ | MHZ | GHZ] U [MA | DB | RI] [R 50]

2. Measurement frequencies in ascending order are specified in the following form:

f_i unc [$s_{11}(f_i)$] unc [$s_{21}(f_i)$] unc [$s_{12}(f_i)$] unc [$s_{22}(f_i)$].

The s-parameters uncertainties are forwarded as follows:

- as extended absolute uncertainties ($k = 2$) for the magnitude of reflection parameters s_{11} and s_{22} , for instance 0.015,
- as extended uncertainties ($k = 2$) in dB for the magnitude of transmission parameters s_{21} and s_{12} , for instance 0.015.

3. Comments: Any line starting with an exclamation mark (!) is interpreted as a comment line.

Two additional values must be specified when the s-parameters are loaded: the lower and the upper nominal measurement limit of the sensor-twoport combination. If s-parameter correction is active, these values are transferred by the sensor in response to *SYSTEM:INFO?* The values cannot always be derived from the lower or upper measurement limit of the sensor alone and from the loss or gain of the preconnected twoport. The upper measurement limit of the sensor-twoport combination may also be limited by the twoport's maximum power-handling capacity. Furthermore, the lower measurement limit may be raised not only by the loss but also by the inherent noise of the twoport. For this reason, these values must be entered manually.

NOTICE *The upper nominal measurement limit of the sensor-twoport combination entered when loading the s-parameters should be carefully specified, as automatic test systems may evaluate it and an incorrect value may cause the sensor and/or the twoport to be overloaded.*

Procedure

To load an s-parameter table into the calibration set of the sensor, proceed as follows:

1. Connect the sensor to the USB port of the PC and start the program module **Update S-Parameters**. The corresponding dialog window is opened (Fig. 3-3).
2. Make sure **Keep Current S-Parameter Data** is deactivated.
3. Under **S-Parameter File** enter the search path and the name of the S2P file containing the parameters. Press the **Browse...** button to open a file-opening dialog where the S2P measurement data file can be easily selected.
4. Under **Uncertainty File** enter the search path and the name of the measurement uncertainty file containing the measurement uncertainty of the s-parameter test system. Press the **Browse...** button to open a file-opening dialog where the measurement uncertainty file can be easily selected.
5. Enter the upper and lower nominal measurement limit of the sensor-twoport combination in the **Lower Power Limit** and **Upper Power Limit** fields.
6. Enter a name for the loaded s-parameter set in the **S-Parameter Device Mnemonic** field. This name can later be queried with *SYSTem:INFO? "SPD Mnemonic"* and is displayed on the NRP basic unit when s-parameter correction is switched on.
7. Activate **S-Parameter Correction on by Default** if the *SENSe:CORRection:SPDevice:STATe* switch should be automatically set to *ON* when the sensor is put into operation.
8. Designations for calibration laboratory and person responsible for calibration may be entered in the **Calibration Lab** and **Calibration Engineer** fields. These designations are stored in the calibration data set. They are implicitly set to „user lab“ and „user“, respectively, if the fields are left blank.
9. Press **Start** for loading. (The dialog is closed with **OK** and the set parameters are retained. When the dialog is exited with **Cancel**, all parameter modifications are ignored.)

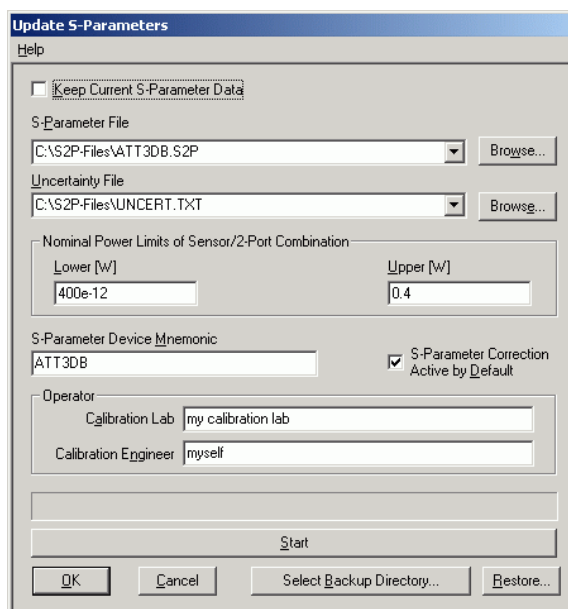

Fig. 3-3 Dialog window for loading an s-parameter table

During loading, the current calibration data set of the sensor is overwritten. To be on the safe side, a backup copy of the current calibration data set is therefore automatically stored before s-parameters are loaded. The names of the backup files have the structure <type>_<batch number>_<date>_<time>.bak, where <type> is the sensor type, <batch number> is the batch number of the sensor, <date> the date of the s-parameter update in *yyyymmdd* format and <time> the time of the s-parameter update in the

format hhmss. By default, a subdirectory named “Backup” is created for the backup files in the program directory. With **Select Backup Directory ...** it is possible to select a different directory.



Store the automatically created backup files on a separate data medium (e.g. diskette, CD-ROM or network drive) and, if required, assign a meaningful name to them to simplify reloading. With the aid of these files, a previously used calibration data set of the sensor can be restored.

To reload the backup file of a calibration data set into the sensor, proceed as follows:

1. Press the **Restore...** button. The **Restore S-Parameters** window is opened (Fig. 3-4).
2. Enter the search path and the name of the backup file in the **Backup File** field. Press the **Browse...** button to open a dialog where the backup file can be easily selected.
3. Press **OK** to start the restore procedure. (With **Cancel** the dialog window is exited without data being restored).

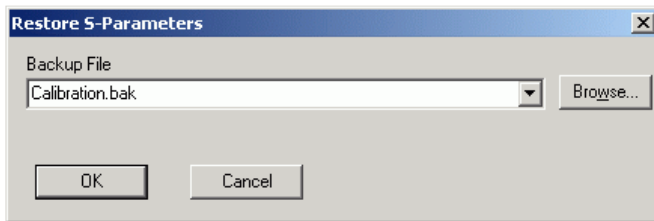

Fig. 3-4 Dialog window for loading the backup file of a calibration data set

To be able to determine if the s-parameter correction is active after plugging in or resetting the sensor, proceed as follows:

1. Connect the sensor to the USB port of the PC and start the program module **Update S-Parameters**.
2. Make sure **Keep Current S-Parameter Data** is activated (Fig. 3-5).
3. Activate **S-Parameter Correction on by Default** if the *SENSe:CORRection:SPDevice:STATe* switch should be automatically set to *ON* when the sensor is put into operation, otherwise deactivate it.
4. Press **Start** for loading.

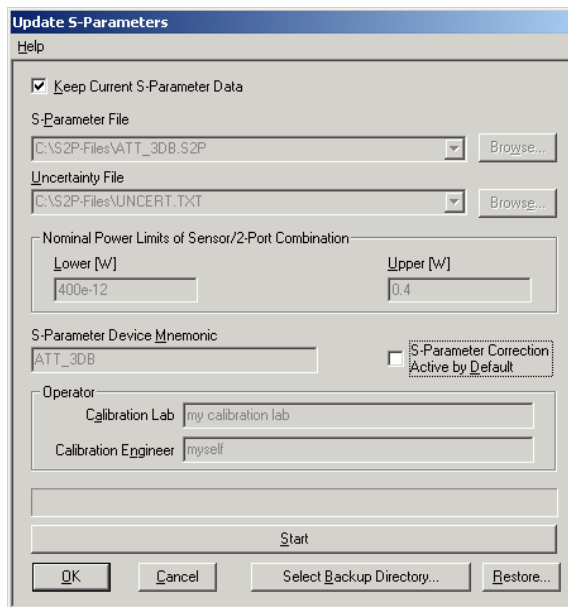

Fig. 3-5 Subsequently changing the default behaviour of the s-parameter correction

Table of Contents

5 Remote Control – Fundamentals5.1

5 Remote Control – Fundamentals

Rohde & Schwarz recommends to utilize the VXI Plug & Play Driver for the remote control of R&S NRP power sensors. This driver can be found on the CD-ROM supplied with the sensor or downloaded in its most recent version via the internet (<http://rohde-schwarz.com/>).

The old remote control interface provided by the *Dynamic Link Library NrpControl.dll* is not developed further, but remains on the CD-ROM and can be downloaded via the internet.

Table of Contents

6 Remote Control – Commands	6.1
Notation	6.1
Commands as per IEEE 488.2	6.2
*IDN? – Identification Query	6.2
*RST – Reset	6.2
*TRG – Trigger.....	6.2
*TST? – Self Test Query.....	6.2
SCPI Commands	6.3
CALibration	6.3
CALibration:DATA[?] <calibration data set as <i>definite length block</i> >	6.3
CALibration:DATA:LENGth?.....	6.3
CALibration:ZERO:AUTO[?] LFR UFR ONCE	6.3
CALibration:ZERO:FAST:AUTO[?] ONCE	6.4
SENSe (Sensor Configuration).....	6.5
SENSe:AUXiliary[?] NONE MINMAX RNDMAX.....	6.10
SENSe:AVERAge:COUNt[?] 1 to 2 ²⁰	6.10
SENSe:AVERAge:COUNt:AUTO[?] OFF ON ONCE.....	6.10
SENSe:AVERAge:COUNt:AUTO:MTIME[?] 1.0 to 999.99	6.11
SENSe:AVERAge:COUNt:AUTO:NSRatio[?] 0.0001 to 1.0	6.11
SENSe:AVERAge:COUNt:AUTO:RESolution[?] 1 to 4	6.11
SENSe:AVERAge:COUNt:AUTO:SLOT[?] 1 to <SENSe:POWer:TSLot:AVG:COUNt>.....	6.11
SENSe:AVERAge:COUNt:AUTO:TYPE[?] RESolution NSRatio.....	6.11
SENSe:AVERAge:RESet.....	6.12
SENSe:AVERAge:STATe[?] OFF ON	6.12
SENSe:AVERAge:TCONtrol[?] MOVing REPeat.....	6.12
SENSe:BWIDth:VIDeo[?] "300 kHz" "1.5 MHz" "5 MHz" "FULL"	6.13
SENSe:BWIDth:VIDeo:LIST?	6.13
SENSe:CORRection:DCYClE[?] 0.001 to 99.999.....	6.13
SENSe:CORRection:DCYClE:STATe[?] OFF ON	6.13
SENSe:CORRection:OFFSet[?] –200.0 to 200.0	6.14
SENSe:CORRection:OFFSet:STATe[?] OFF ON	6.14
SENSe:CORRection:SPDevice:LIST?	6.14
SENSe:CORRection:SPDevice:SELeCt[?] <device_number>	6.14
SENSe:CORRection:SPDevice:STATe[?] OFF ON	6.15
SENSe:FREQUency[?] 50.0e6 to 18.0e9 (NRP-Z81), ...40.0e9 (NRP-Z85, NRP-Z86 Var. 40) or ...44.0e9 (NRP-Z85, NRP-Z86 Var. 44)	6.15
SENSe:FUNcTION[?] <sensor_function>.....	6.15
SENSe:POWer:AVG:APERture[?] 1.0e-6 ... 1.0.....	6.18
SENSe:POWer:AVG:BUFFer:SIZE[?] 1 to 8192.....	6.19
SENSe:POWer:AVG:BUFFer:STATe[?] OFF ON	6.19
SENSe:POWer:AVG:SMOothing:STATe[?] OFF ON.....	6.19
SENSe:POWer:BURSt:DTOLerance[?] 0.0 to 0.3	6.19
SENSe:POWer:TSLot[:AVG]:COUNt[?] 1 to 16	6.20

SENSE:POWER:TSLot[:AVG][:EXCLude]:MID:OFFSet[:TIME][?] 0.0 to 0.16.20

SENSE:POWER:TSLot[:AVG][:EXCLude]:MID:TIME[?] 0.0 to 0.16.21

SENSE:POWER:TSLot[:AVG]:WIDTh[?] 50e-9 to 0.16.21

SENSE:SGAMma:CORRection:STATe[?] OFF | ON6.22

SENSE:SGAMma:MAGNitude[?] 0.0 to 1.0.....6.22

SENSE:SGAMma:PHASe[?] -360.0 to 360.0.....6.23

SENSE:STATistics[:EXCLude]:MID:OFFSet[:TIME][?] 0.0 to 0.36.23

SENSE:STATistics[:EXCLude]:MID:TIME[?] 0.0 to 0.36.23

SENSE:STATistics:OFFSet:TIME[?] 0.0 to 10.06.23

SENSE:STATistics:SCALE:X:MPWidth?6.23

SENSE:STATistics:SCALE:X:POINts[?] 3 to 81916.23

SENSE:STATistics:SCALE:X:RANGe[?] 0.01 to 1006.24

SENSE:STATistics:SCALE:X:RLEVel[?] -80 to +20.....6.24

SENSE:STATistics:TIME[?] 10.0e-6 to 0.3.....6.24

SENSE:TIMing:EXCLude:STARt[?] 0.0 to 106.24

SENSE:TIMing:EXCLude:STOP[?] 0.0 to 51.2e-66.24

SENSE:TRACe:AVERAge:COUNt[?] 1 to 65536.....6.25

SENSE:TRACe:AVERAge:STATe[?] OFF | ON.....6.26

SENSE:TRACe:AVERAge:TCONtrol[?] MOVing | REPeat.....6.26

SENSE:TRACe:ESAMpling:AUTO[?] OFF | ON.....6.27

SENSE:TRACe:MEASurement:ALGorithm [?] HISTogram | INTegration | PEAK6.27

SENSE:TRACe:MEASurement:AUTO[?] OFF | ON6.27

SENSE:TRACe:MEASurement:DEFine:DURation:REFerence[?] 0.0 ... 100.06.28

SENSE:TRACe:MEASurement:DEFine:TRANsition:HREFerence[?] 0.0 ... 100.0....6.28

SENSE:TRACe:MEASurement:DEFine:TRANsition:LREFerence[?] 0.0 ... 100.06.28

SENSE:TRACe:MEASurement:OFFSet:TIME[?] -x to 10.0.....6.28

SENSE:TRACe:MEASurement:POWER:AVG?6.28

SENSE:TRACe:MEASurement:POWER:HREFerence?6.28

SENSE:TRACe:MEASurement:POWER:LREFerence?.....6.29

SENSE:TRACe:MEASurement:POWER:MAX?6.29

SENSE:TRACe:MEASurement:POWER:MIN?6.29

SENSE:TRACe:MEASurement:POWER:PULSe:BASE?6.30

SENSE:TRACe:MEASurement:POWER:PULSe:TOP?6.30

SENSE:TRACe:MEASurement:POWER:REFerence?.....6.30

SENSE:TRACe:MEASurement:PULSe:DCYClE?6.30

SENSE:TRACe:MEASurement:PULSe:DURation?.....6.30

SENSE:TRACe:MEASurement:PULSe:PERiod?6.30

SENSE:TRACe:MEASurement:PULSe:SEParation?6.30

SENSE:TRACe:MEASurement:STATe[?] OFF | ON.....6.31

SENSE:TRACe:MEASurement:TIME[?] 0.0 ... 10.06.31

SENSE:TRACe:MEASurement:TRANsition:ESAMpling:AUTO[?] OFF | ON.....6.31

SENSE:TRACe:MEASurement:TRANsition:NEGative:DURation?6.31

SENSE:TRACe:MEASurement:TRANsition:NEGative:OCCurrence?6.31

SENSE:TRACe:MEASurement:TRANsition:NEGative:OVERshoot?6.32

SENSE:TRACe:MEASurement:TRANsition:POSitive:DURation?6.32

SENSE:TRACe:MEASurement:TRANsition:POSitive:OCCurrence?6.32

SENSe:TRACe:MEASurement:TRANSition:POSitive:OVERshoot?	6.32
SENSe:TRACe:MEASurement:TRANSition:SPERiod?	6.32
SENSe:TRACe:MPWidth?	6.32
SENSe:TRACe:OFFSet:TIME[?] -x to 10.0	6.33
SENSe:TRACe:POINts[?] 3 to 8192	6.33
SENSe:TRACe:POINts:FPGA?	6.33
SENSe:TRACe:TIME[?] 50e-9 to 1	6.34
SENSe:TRACe:TIME:FPGA?	6.34
SYSTem	6.35
SYSTem:FEATures?	6.35
SYSTem:INFO? [Item]	6.35
SYSTem:INITialize	6.37
SYSTem:LIMits?	6.37
SYSTem:MINPower?	6.37
SYSTem:RUTime 0 to 10.0	6.37
SYSTem:SUTime 0 to 10.0	6.38
SYSTem:TRANSaction:BEGIN	6.38
SYSTem:TRANSaction:END	6.38
TEST	6.39
TEST:SENSor?	6.39
TRIGger	6.40
ABORt	6.40
INITiate:CONTInuous[?] OFF ON	6.40
INITiate:IMMediate	6.41
TRIGger:ALEVel:STATe[?] OFF ON	6.41
TRIGger:ATRigger:STATe[?] OFF ON	6.41
TRIGger:COUNt[?] 1 to 2 ³¹	6.42
TRIGger:DELay[?] -x to 10.0	6.42
TRIGger:DTIME[?] 0.0 to 10.0	6.43
TRIGger:HOLDoff[?] 0.0 to 10.0	6.43
TRIGger:HYSteresis[?] 0.0 to 10.0	6.44
TRIGger:IMMediate	6.44
TRIGger:LEVel[?] 1.0e-6 to 0.1	6.44
TRIGger:MASter:STATe[?] OFF ON	6.44
TRIGger:SLOPe[?] POSitive NEGative	6.45
TRIGger:SOURce[?] HOLD IMMediate INTernal BUS EXTernal	6.45
TRIGger:SYNChronisation:STATe OFF ON	6.45
List of Remote-Control Commands	6.46

Figs.

Fig. 6-1	Effect of <i>SENSe:POWer:BURSt:DTOLerance</i>	6.20
Fig. 6-2	Effect of an exclusion interval in the Timeslot mode.....	6.21
Fig. 6-3	Correction of interactions between the power sensor and the signal source	6.22
Fig. 6-4	Correction of interactions between the power sensor, the signal source, and the s-parameter device	6.22
Fig. 6-5	Effect of <i>SENSe:TIMing:EXCLude:STARt</i> and <i>:STOP</i> in the <i>Burst Average</i> mode	6.25
Fig. 6-6	Effect of <i>SENSe:TIMing:EXCLude:STARt</i> and <i>:STOP</i> in the <i>Timeslot</i> mode	6.25
Fig. 6-7	Magnitude parameters of a trace	6.29
Fig. 6-8	Time parameters and reference levels of a trace	6.29
Fig. 6-9	Effect of the <i>dropout time</i> parameter	6.43

Tables

Table 6-1	Commands of the <i>CALibration</i> group	6.3
Table 6-2	Commands of the <i>SENSe</i> system	6.5
Table 6-3	Video bandwidth and resulting sampling rate and interval	6.13
Table 6-4	Measurement modes	6.15
Table 6-5	<i>SYSTem</i> command group.....	6.35
Table 6-6	Meaning of <i>Item</i> in the <i>SYSTem:INFO?</i> command	6.35
Table 6-7	<i>TEST</i> command group	6.39
Table 6-8	<i>TRIGger</i> command group	6.40
Table 6-9	List of remote-control commands.....	6.46

6 Remote Control – Commands

Notation

In the following sections, all commands implemented in the sensor are first listed in a table according to command systems and are then described in detail. The notation is largely in line with the SCPI standard.

Command tables For a quick overview of available commands, the commands are listed in a table before they are described. These tables contain the following four columns:

Command:	Commands and their tree structure
Parameters:	Possible parameters
Unit:	The basic unit of the physical parameters (must not be sent with parameters)
Remarks:	Identification of all commands <ul style="list-style-type: none"> • that have no query form • that are available as query only

Indentations The various levels of the SCPI command hierarchy are shown in the table by right indentations. The lower the level, the greater the indentation to the right. It should be noted that the complete notation of the command includes the higher levels too.

Example:

SENSe:AVERage:COUNT is represented in the table as follows:

```
SENSe          first level
  :AVERage     second level
    :COUNT    third level
```

In the individual description, the command is shown full length. An example of the command is given at the end of the description.

[?]
?

A question mark in square brackets at the end of a command indicates that this command can either be used as a setting command (without question mark) or as a query (with question mark). If the question mark is not in square brackets, the command is a query only.

Example:

SENSe:POWer:AVG:APERture[?]

SENSe:POWer:AVG:APERture 1e-3 sets the length of the sampling window to 1 ms.

SENSe:POWer:AVG:APERture? returns the currently set length as a response.

**IDN?* queries the sensor identification string which, of course, cannot be changed. For this reason, this command is only available as a query.

Special character | between parameters

A vertical bar between parameters is used to separate alternative options (ORing).

Example:

NITiate:CONTInuous OFF | ON

Either *OFF* or *ON* can be entered.

{numeric expression}

A numeric expression in curly brackets means that it has been rounded to the nearest integer.

<parameter>
<variable>

The current value of a parameter or variable is represented by placing the parameter or variable in triangular brackets.

Commands as per IEEE 488.2

The power sensor supports a subset of the possible setting commands and queries (*common commands and queries*) in line with IEEE 488.2.

*IDN? – Identification Query

*IDN? returns a string identifying the sensor (device identification code). The version number of the installed firmware is indicated. The string for a sensor of type R&S NRP-Z81 has the following structure:

ROHDE&SCHWARZ,NRP-Z81,<serial number>,<firmware version>

<serial number>: serial number in ASCII

<firmware version>: firmware version number in ASCII

*RST – Reset

*RST sets the sensor to the default state, i.e. the default settings for all test parameters are loaded.

*TRG – Trigger

*TRG triggers a measurement. For this purpose, the sensor must be in the *WAIT_FOR_TRIGGER* state and the source for the trigger event must be set to *BUS (TRIGger:SOURce BUS)*.

*TST? – Self Test Query

*TST? starts a selftest and returns 0 (no error found) or 1 (an error has occurred). The selftest comprises the following functions:

- RAM test
- Operating voltages
- Temperature measurement
- Calibration data set
- Noise
- Zero-point offsets

SCPI Commands

The R&S NRP-Z81/85/86 power sensor is controlled via the command groups

- CALibration (zeroing)
- SENSE (measurement configurations)
- SYSTem
- TRIGger
- SERVice

CALibration

Table 6-1 Commands of the *CALibration* group

Command	Parameter	Unit	Remarks
CALibration			
:DATA[?]	<calibration data set as definite length block>		
:LENGth?		Bytes	Query only
:ZERO			
:AUTO[?]	LFR UFR ONCE		
:FAST:AUTO[?]	ONCE		Only in Trace or Statistics mode

CALibration:DATA[?] <calibration data set as *definite length block*>

CALibration:DATA is used to write a calibration data set to the sensor's flash memory.

The query returns the calibration data set currently stored in the flash memory as a *definite length block*.

CALibration:DATA:LENGth?

CALibration:DATA:LENGth? returns the length in bytes of the calibration data set currently stored in the flash memory. Programs that read out the calibration data set can use this information to determine the capacity of the buffer memory required.

CALibration:ZERO:AUTO[?] LFR | UFR | ONCE

These commands zero the sensor. For this purpose, the test signal must be deactivated or the sensor disconnected from the signal source. The sensor automatically detects the presence of any significant power to be measured. This causes zeroing to be aborted and the error message *NRPEROR_CALZERO* to be output.

Full zeroing, covering all measurement modes and the entire frequency range, can be carried out with the *ONCE* parameter. Usually, this takes eight seconds. There are a number of ways to reduce the time taken. Zeroing can be limited to the frequency range <500 MHz or ≥ 500 MHz by using the parameters *LFR* (lower frequency range) and *UFR* (upper frequency range), cutting the zeroing time by half. Zeroing is even faster if performed only in the *Trace* mode and the *Statistics* modes (20 ms – see the command group *CALibration:ZERO:FAST:AUTO*).

The query always returns 1.

Default setting

After a power-on reset, the zero offsets stored in the data memory of the sensor are used as corrections. Since they were determined after sensor warm-up during factory calibration, only moderate zero errors are to be expected if no zeroing is performed. After initialization of the sensor by means of **RST* or *SYSTEM:INITialize*, the current zero setting remains unchanged.



Repeat zeroing

- during warm-up after switching on the R&S NRP or connecting the sensor
- after a substantial change in the ambient temperature
- after connecting the sensor to an RF connector if the ambient temperature is high
- after several hours in operation
- when very low-power signals are to be measured, e.g. less than 10 dB above the lower measurement limit of the sensor

When zeroing, preferably switch off the test signal and do not remove the sensor from the signal source. Apart from keeping the thermal balance, this has the advantage that the noise superimposed on the test signal (e.g. from a broadband amplifier) can be detected on zeroing and does not impair the measurement result.

CALibration:ZERO:FAST:AUTO[?] ONCE

The command *CALibration:ZERO:FAST:AUTO ONCE* performs fast zeroing, but can be called only in the sensor's *Trace* mode and *Statistics* modes. In any other measurement mode, the error message *NRPEROR_CALZERO* is output. Even though the execution time is shorter than that for standard zeroing by a factor of 100 or more, measurement accuracy is not affected. Fast zeroing is available for the entire frequency range.

The query always returns 1.

Default setting

After a power-on reset, the zero offsets stored in the data memory of the sensor are used as corrections. Since they were determined after sensor warm-up during factory calibration, only moderate zero errors are to be expected if no zeroing is performed. After initialization of the sensor by means of **RST* or *SYSTEM:INITialize*, the current zero setting remains unchanged.

SENSe (Sensor Configuration)

The sensor is configured by means of the commands in the *SENSe* and *TRIGger* groups.

Table 6-2 Commands of the *SENSe* system

Command	Parameter	Unit	Remarks
SENSe			
:AUXiliary[?]	NONE MINMAX RNDMAX		
:AVERage			
:COUNt[?]	1 to 2 ²⁰		
:AUTO[?]	OFF ON ONCE		
:MTIME[?]	1.0 to 999.99	s	
:NSRatio[?]	0.0001 to 1.0	dB	
:RESolution[?]	1 to 4		
:SLOT[?]	1 to <SENSe:POWer:TSLot:AVG:COUNt>		
:TYPE[?]	RESolution NSRatio		
:RESet			No query
:STATe[?]	OFF ON		
:TCONtrol[?]	MOVing REPeat		
:BWIDth			
:VIDeo[?]	"300 kHz" "1.5 MHz" "5 MHz" "FULL"		
:LIST?			Query only
:CORRection			
:DCYCle[?]	0.001 to 99.999	%	
:STATe[?]	OFF ON		
:OFFSet[?]	-200.0 to 200.0	dB	
:STATe[?]	OFF ON		
:SPDevice			
:LIST?			Query only
:SELEct[?]	1 to x		
:STATe[?]	OFF ON		

Command	Parameter	Unit	Remarks
:FREQuency[?]	50.0e6 to 18.0e9 (NRP-Z81), ...40.0e9 (NRP-Z85, NRP-Z86 Var. 40) or ...44.0e9 (NRP-Z85, NRP-Z86 Var. 44)	Hz	
:FUNcTion[?]	"POWer:AVG" "POWer:BURSt:AVG" "POWer:TGATe:AVG" "POWer:TSLot:AVG" "XTIME:POWer" "XPOWer:CCDFunction" "XPOWer:PDFunction"		
:POWer			
:AVG			
:APERture[?]	1.0e-6 to 1.0	s	
:BUFFer			
:SIZE[?]	1 to 8192		
:STATe[?]	OFF ON		
:SMOothing:STATe[?]	OFF ON		
:BURSt			
:DTOLerance[?]	0.0 to 0.3	s	
:TSLot[:AVG]			
:COUNt[?]	1 to 16		
[:EXCLUDE]:MID			
:OFFSet[:TIME][?]	0.0 to 0.1	s	
:TIME[?]	0.0 to 0.1	s	
:WIDTh[?]	50.0e-9 to 0.1	s	
:SGAMma			
:CORRection:STATe[?]	OFF ON		
:MAGNitude[?]	0.0 to 1.0		
:PHASe[?]	-360.0 to 360.0	degree	
:STATistics			
[:EXCLUde]:MID			
:OFFSet[:TIME][?]	0 to 0.3	s	
:TIME[?]	0 to 0.3	s	
:OFFSet:TIME[?]	0 to 10.0	s	

Command	Parameter	Unit	Remarks
:SCALE:X			
:MPWidth?			Query only
:POINTs[?]	3 to 8191		
:RANGe[?]	0.01 to 100.0	dB	
:RLEVel[?]	-80 to +20	dBm	
:TIME[?]	10.0e-6 to 0.3	s	
:TIMing			
:EXCLude			
:STARt[?]	0.0 to 10.0	s	
:STOP[?]	0.0 to 51.2e-6	s	
:TRACe			
:AVERage			
:COUNt[?]	1 to 65536		
:STATe[?]	OFF ON		
:TCONtrol[?]	MOVing REPeat		
:ESAMpling:AUTO[?]	OFF ON		
:MEASurement			
:ALGorithm[?]	HISTogram INTegration PEAK		
:AUTO[?]	OFF ON		
:DEFine			
:DURation			
:REFerence[?]	0.0 ... 100.0	%	
:TRANsition			
:LREFerence[?]	0.0 ... 100.0	%	
:HREFerence[?]	0.0 ... 100.0	%	
:OFFSet:TIME[?]	0.0 ... 10.0	s	
:POWER			
:MIN?		W	Query only
:MAX?		W	Query only

Command	Parameter	Unit	Remarks
:AVG?		W	Query only
:PULSe			
:TOP?		W	Query only
:BASE?		W	Query only
:LREference?		W	Query only
:HREference?		W	Query only
:REference?		W	Query only
:PULSe			
:DCYClE?		%	Query only
:DURation?		s	Query only
:PERiod?		s	Query only
:SEParation?		s	Query only
:STATe[?]	OFF ON		
:TIME[?]	0.0 ... 10.0	s	0.0 = disabled
:TRANsition			
:ESAMpling:AUTO[?]	OFF ON		
:NEGative			
:DURation?		s	Query only
:OCCurrence?		s	Query only
:OVERshoot?		%	Query only
:POSitive			
:DURation?		s	Query only
:OCCurrence?		s	Query only
:OVERshoot?		%	Query only
:SPERiod?		s	Query only
:MPWidth?		s	Query only
:OFFSet:TIME[?]	x to 10.0	s	
:POINts[?]	3 to 8192		
:FPGA?			Query only

Command	Parameter	Unit	Remarks
:TIME[?]	50e-9 to 1	s	
:FPGA?		s	Query only

SENSe:AUXiliary[?] NONE | MINMAX | RNDMAX

This command is used to define which measurement results are to be made available in addition to the average power (in the *Timeslot Average* and *Trace* modes: in addition to the average power of each timeslot or pixel, respectively).

- *NONE*: Only the average power of the associated samples is provided.
- *MINMAX*: The maximum and minimum are additionally provided.
- *RNDMAX*: The maximum and a random sample are additionally provided.

The query returns

- 1 for *NONE*,
- 2 for *MINMAX*
- 4 for *RNDMAX*

Default setting: *RNDMAX*

SENSe:AVERage:COUNT[?] 1 to 2²⁰

SENSe:AVERage:COUNT sets the number of measured values that have to be averaged to form the measurement result in the modes *Continuous Average*, *Burst Average*, or *Timeslot Average*. The greater this averaging factor, the less the measured values fluctuate and the longer the measurement time. The parameter is rounded to the nearest power-of-two. If an averaging factor of two or more has been chosen, the measurement is performed with chopper-stabilization in the *Burst Average* and *Timeslot Average* modes. Chopper stabilization is always activated in the *Continuous Average* mode.

The query returns the averaging factor that has been set.



The averaging function must be activated with *SENSe:AVERage:STATe ON* so that the set averaging factor becomes effective.

Default setting: 1024

SENSe:AVERage:COUNT:AUTO[?] OFF | ON | ONCE

SENSe:AVERage:COUNT:AUTO ON activates auto-averaging in the modes *Continuous Average*, *Burst Average* and *Timeslot Average*. *SENSe:AVERage:COUNT:AUTO OFF* deactivates it. If auto-averaging is activated, the averaging factor is continuously determined and set according to the power level and other parameters. On deactivation, the previous, automatically determined averaging factor is used in the fixed-filter mode. The *SENSe:AVERage:COUNT:AUTO ONCE* command ensures that a new averaging factor is determined by the automatic filter function under the current measurement conditions and is used in the fixed-filter mode.

In the *Burst Average* and *Timeslot Average* modes, a minimum value of two is selected for the averaging factor. This prevents implicit deactivation of chopper stabilization in course of automatic averaging.

The query returns

- 1 for *OFF*
- 2 for *ON*

Default setting: *OFF*

SENSe:AVERAge:COUNT:AUTO:MTIME[?] 1.0 to 999.99

SENSe:AVERAge:COUNT:AUTO:MTIME sets an upper limit for the settling time of the auto-averaging filter in the *NSRatio* mode and thus limits the length of the filter.

The query returns the time that has been set.

Default setting: 4 [s]

SENSe:AVERAge:COUNT:AUTO:NSRatio[?] 0.0001 to 1.0

SENSe:AVERAge:COUNT:AUTO:NSRatio sets an upper limit for the relative noise content of the measurement result in the *NSRatio* auto-averaging mode. The relative noise content is defined as the magnitude in dB of the level variation caused by the inherent noise of the sensor (two standard deviations).

The query returns the set relative noise content.

Default setting: 0.01 [dB]

SENSe:AVERAge:COUNT:AUTO:RESolution[?] 1 to 4

SENSe:AVERAge:COUNT:AUTO:RESolution sets the resolution index for the automatic averaging filter if it is operated in the *RESolution* mode. The resolution index is greater by a value of 1 than the number of decimal places that have to be taken into account to further process the measurement result in dBm, dB μ V or dB. The design of the *RESolution* mode is similar to that of its predecessors R&S NRVS and R&S NRVD or other commercial power meters. The higher the selected index, the better the measurement result is filtered. However, it cannot be ensured that the least significant digit (e.g. 0.01 dB with an index of 3) remains stable. The *NSRatio* setting is recommended instead.

The query returns the set resolution index.

Default setting: 3

SENSe:AVERAge:COUNT:AUTO:SLOT[?] 1 to <SENSe:POWer:TSLot:AVG:COUNT>

SENSe:AVERAge:COUNT:AUTO:SLOT defines a timeslot whose power is used as a reference for the auto-averaging filter in the *Timeslot* mode. The reference timeslot is addressed via a number, the numbers starting at 1. This number must not exceed the total number of timeslots which can be set with the *SENSe:POWer:TSLot:AVG:COUNT* command. If the total number is reduced to a value that is smaller than the reference-timeslot number, then the timeslot with the highest number is automatically chosen as a reference.

The query returns the reference-timeslot number.

Default setting: 1

SENSe:AVERAge:COUNT:AUTO:TYPE[?] RESolution | NSRatio

SENSe:AVERAge:COUNT:AUTO:TYPE defines the operating mode of the automatic averaging filter in the *Continuous Average*, *Burst Average* or *Timeslot Average* modes. The *RESolution* parameter sets an operating mode that is usually implemented in power meters; *NSRatio* ensures that the noise content of the measurement result does not exceed a predefined limit.

The query returns

- 1 for *RESolution*
- 2 for *NSRatio*

Default setting: *RESolution*

SENSe:AVERage:RESet

SENSe:AVERage:RESet initializes the averaging filter in the *Continuous Average*, *Burst Average* or *Timeslot Average* measurement modes. This is useful if the averaging filter is operated in the *SENSe:AVERage:TCONtrol MOVing* filter mode and a high averaging factor has been set. In this case, rapid changes in the measured power will be delayed to such an extent that the advantage of the *MOVing* filter mode is lost. The *SENSe:AVERage:RESet* command solves this problem by initially setting the length of averaging filter to a minimum value and filling it with the current measured value. The averaging factor is then automatically increased to its final value which is determined by the *SENSe:AVERage:COUNt* command. In this way, changes in the measurement result become quickly apparent and fluctuations in the measurand are still filtered out in accordance with the set averaging factor. However, this procedure does not reduce the time required to obtain a fully settled reading.

SENSe:AVERage:STATe[?] OFF | ON

SENSe:AVERage:STATe switches the averaging filter for the *Continuous Average*, *Burst Average* or *Timeslot Average* modes on or off. If an averaging factor of two or more has been chosen, the measurement is performed with chopper-stabilization in the *Burst Average* and *Timeslot Average* modes. Chopper stabilization is always activated in the *Continuous Average* mode.

The query returns

- 1 for *OFF*
- 2 for *ON*

Default setting: *ON*

SENSe:AVERage:TCONtrol[?] MOVing | REPeat

SENSe:AVERage:TCONtrol (*terminal control*) defines the behavior of the averaging filter in the *Continuous Average*, *Burst Average* or *Timeslot Average* modes.

When the *REPeat* parameter is included, a measurement result is output after the averaging filter has been completely filled with new measured values. This ensures that a settled result is output. Very long measurement times may be the consequence of large averaging factors.

When the *MOVing* parameter is used in a setting command, a moving average is formed, which means that with every new measured value, a new output value is also available. This is advantageous if a large averaging factor has been selected, as trends emerge quickly and there is no need to wait for the full settling time to elapse. The output rate can be varied over a wide range to prevent an intermediate result overload (see the *SYStem:RUTime* command).

The query returns

- 1 for *MOVing*
- 2 for *REPeat*

Default setting: *REPeat*

SENSe:BWIDth:VIDeo[?] "300 kHz" | "1.5 MHz" | "5 MHz" | "FULL"

This command can be used to reduce the video bandwidth for the *Trace* and *Statistics* modes. As a result, trigger sensitivity is increased and the display noise reduced. To prevent signals from being corrupted, the selected video bandwidth should not be smaller than the RF bandwidth of the measurement signal. The "FULL" setting corresponds to a video bandwidth of at least 30 MHz if there is an associated frequency setting (*SENSe:FREQuency* command) greater than or equal to 500 MHz. If a frequency below 500 MHz is set and the video bandwidth is set to "FULL", the video bandwidth is automatically reduced to approx. 7.5 MHz.

If the video bandwidth is limited with the *SENSe:BWIDth:VIDeo* command, the sampling rate is also automatically reduced, i.e. the effective time resolution in the *Trace* mode is reduced accordingly. In the *Statistics* modes, the measurement time must be increased appropriately if the required sample size is to be maintained:

Table 6-3 Video bandwidth and resulting sampling rate and interval

Video bandwidth	Sampling rate	Sampling interval
"Full"	$8 \times 10^7 \text{ s}^{-1}$	12.5 ns
"5 MHz"	$4 \times 10^7 \text{ s}^{-1}$	25 ns
"1.5 MHz"	$1 \times 10^7 \text{ s}^{-1}$	100 ns
"300 kHz"	$2,5 \times 10^6 \text{ s}^{-1}$	400 ns

The sampling interval can be queried with the *SENSe:TRACe:MPWidth?* command.

Default setting: "FULL"

SENSe:BWIDth:VIDeo:LIST?

This query command outputs all available video-bandwidth settings.

SENSe:CORRection:DCYClE[?] 0.001 to 99.999

SENSe:CORRection:DCYClE sets the duty cycle as a percentage when pulse-modulated signals are corrected. With the correction activated, the sensor calculates pulse power from the duty cycle and average power. The duty cycle is only evaluated in the *Continuous Average* mode.

The query returns the current duty cycle in percent.

Default setting: 1.0 [%]

SENSe:CORRection:DCYClE:STATe[?] OFF | ON

SENSe:CORRection:DCYClE:STATe ON activates duty cycle correction and thus pulse-power measurement, whereas *SENSe:CORRection:DCYClE:STATe OFF* deactivates it.

The query returns

- 1 for OFF
- 2 for ON

Default setting: OFF

SENSe:CORRection:OFFSet[?] -200.0 to 200.0

SENSe:CORRection:OFFSet defines a fixed offset in dB which is used to correct the measured value. (When a log scale is used, the offset is added to the measured value; this is the reason why the command has this name.)

The attenuation of an attenuator located ahead of the sensor or the coupling attenuation of a directional coupler is taken into account with a positive offset, i.e. the sensor calculates the power at the input of the attenuator or directional coupler. A negative offset can be used to correct the influence of an amplifier connected ahead.

The query returns the set offset in dB.

Default setting: 0.0 [dB]

SENSe:CORRection:OFFSet:STATe[?] OFF | ON

SENSe:CORRection:OFFSet:STATe ON activates the offset correction and *SENSe:CORRection:OFFSet:STATe OFF* deactivates it.

The query returns

- 1 for OFF
- 2 for ON

Default setting: OFF

SENSe:CORRection:SPDevice:LIST?

Several S-parameter data sets can be loaded onto the R&S NRP-Z81/85/86 power sensor. This query command outputs a list of the data sets that have been loaded; the list indicates the consecutive number and mnemonic of each data set.

SENSe:CORRection:SPDevice:SELEct[?] <device_number>

Several S-parameter data sets can be loaded onto the R&S NRP-Z81/85/86 power sensor. The *SENSe:CORRection:SPDevice:SELEct* command can be used to select a loaded data set for S-parameter correction. This data set is accessed by means of a consecutive number, starting with 1 for the first data set. If an invalid data set consecutive number is entered, an error message is output.

The query command returns the consecutive number of the selected S-parameter data set.

Default setting:

When the S-parameter data sets are being loaded, the user can specify the S-parameter data set to be used as default setting.

SENSe:CORRection:SPDevice:STATe[?] OFF | ON

SENSe:CORRection:SPDevice:STATe ON activates S-parameter correction by setting the selected S-parameter data set (see the *SENSe:CORRection:SPDevice:SELEct* command). The *OFF* parameter deactivates S-parameter correction.

S-parameter correction is used to compensate for a component (attenuator, directional coupler) connected ahead of the sensor by means of its S-parameter data set. The use of S-parameters instead of a fixed offset (see *SENSe:CORRection:OFFSet* command group) allows more precise measurements because the interaction between the sensor and the component can be taken into account. The R&S NRP-Z81/85/86 wideband power sensor contains no factory-set S-parameter data set. As a result, the *SENSe:CORRection:SPDevice:STATe ON* command generates an error message, if no user-defined data set is available. For detailed information on loading S-parameter data sets, see section 3.

The query returns

- 1 for *OFF*
- 2 for *ON*

Default setting:

The sensor's factory-set default setting is *OFF*. The default setting can be redefined when an S-parameter table is loaded (see section 3).

SENSe:FREQUency[?] 50.0e6 to 18.0e9 (NRP-Z81), ...40.0e9 (NRP-Z85, NRP-Z86 Var. 40) or ...44.0e9 (NRP-Z85, NRP-Z86 Var. 44)

SENSe:FREQUency transfers the carrier frequency of the RF signal to be measured to the sensor; this frequency is used for various corrections of the measurement result. When the R&S NRP- Z81/85/86 power sensor is used, it is essential that the current carrier frequency is set. Otherwise, non-linearities or temperature dependencies considerably greater than those stated in the data sheet can occur. If the frequency that is entered is below 500 MHz, the video bandwidth of the sensor is automatically reduced (see *SENSe:BWIDth:VIDEo* command). The center frequency is set for broadband signals (*spread-spectrum* signals, multicarrier signals), if there is no explicit carrier.

The query returns the set carrier frequency in Hz.

Default setting: 1.0e9 [Hz]

SENSe:FUNCTion[?] <sensor_function>

SENSe:FUNCTion <sensor_function> sets the sensor to one of the following measurement modes:

Table 6-4 Measurement modes

<sensor_function>	Measurement mode designation
"POWeR:AVG"	Continuous Average
"POWeR:BUSt:AVG"	Burst Average
"POWeR:TSLot:AVG"	Timeslot Average
"XTIME:POWeR"	Trace
"XPOWeR:PDFunction"	Statistics (PDF)
"XPOWeR:CCDFunction"	Statistics (CCDF)

The query returns a string indicating the set measurement mode.

Default setting: "POWER:AVG"

Short description of the measurement modes

Continuous Average

In this mode, the average power of the measurement signal is asynchronously measured within definable time intervals (sampling windows). The width of a sampling window is set with the *SENSe:POWer:AVG:APERture* command. The measurements are performed with chopper stabilization to obtain more accurate results with reduced noise and zero offset. Therefore, a measurement is always performed over two sampling windows, the polarity of the detector output signal being reversed for the second window. By taking the difference of the output signals, the influence of the video path on noise and zero drift is minimized.

When the averaging function is activated, the averaging factor determines how often the described measurement cycle is repeated.

A measurement should be started with the command *INITiate:IMMEDIATE* (once) or *INITiate:CONTinuous:ON* (continuously), the trigger source being set to *Immediate* with the *TRIGger:SOURce* command (asynchronous measurement).

In addition to the average power, the following quantities can optionally be output:

- Maximum power
- Minimum power
- A randomly selected sample

The *SENSe:AUXiliary* command is used to make the selection.

Burst Average

This mode is used to measure the average power of bursts. The time interval in which power is measured starts when the power exceeds the trigger level and stops when the trigger logic detects the end of the pulse. To prevent power drops due to modulation being erroneously interpreted as an end of a pulse, the user must define a dropout tolerance with the *SENSe:POWer:BURSt:DTOLerance* command.

When the averaging function is activated (*SENSe:AVERage:STATe ON*), and an averaging factor of two or more has been chosen, measurements are performed with chopper stabilization to obtain more accurate results with reduced noise and zero offset. The same holds true for activated automatic averaging. Chopper stabilization involves that the polarity of the detector output signal is reversed from burst to burst. By taking the difference of the output signals, the effect of the video path on noise and zero drift is minimized.

In the Burst Average mode, only internal trigger events (from the signal) are evaluated, irrespective of the setting of the *TRIGger:SOURce* parameter. The *TRIGger:DELay* setting is also ignored so that the measurement interval starts the instant the signal crosses the trigger threshold. A measurement is initiated with the command *INITiate:IMMEDIATE* (once, irrespective of the number of repetitions required for chopper stabilization and averaging) or *INITiate:CONTinuous:ON* (continuously).

Time intervals that are to be excluded from measurement can be set at the beginning and at the end of the measurement interval (see commands *SENSe:TIMing:EXCLude:START* and *SENSe:TIMing:EXCLude:STOP*).

In addition to the average power, the following quantities can optionally be output:

- Maximum power
- Minimum power
- A randomly selected sample

The *SENSe:AUXiliary* command is used to make the selection.

Timeslot Average

The average power of a definable number of successive timeslots within a frame structure with equal spacing is measured. The width of one slot must be defined with *SENSe:POWer:TSLot:WIDTh*, the number of slots must be defined with *SENSe:POWer:TSLot:COUnT*. The limit is 16 for the R&S NRP-Z81/85/86 wideband power sensor. It is essential to define the *TRIGger:DELay* parameter to ensure that the beginning of the first slot to be measured coincides with the delayed trigger point. The measurement result is an array with the same number of elements as timeslots. Each element represents the average power in a particular timeslot.

When the averaging function is activated (*SENSe:AVERage:STATe ON*), and an averaging factor of two or more has been chosen, measurements are performed with chopper stabilization to obtain more accurate results with reduced noise and zero offset. The same holds true for activated automatic averaging. Chopper stabilization involves that the polarity of the detector output signal is reversed from frame to frame. By taking the difference of the output signals, the effect of the video path on noise and zero drift is minimized.

Time intervals that are to be excluded from the measurement can be set at the beginning, in the middle and at the end of each timeslot (see commands *SENSe:TIMing:EXCLude:STARt*, *SENSe:POWer:TSLot[:AVG][:EXCLUDE]:MID* and *SENSe:TIMing:EXCLude:STOP*).

A measurement is initiated with the command *INITiate:IMMediate* (once, irrespective of the number of repetitions required for averaging) or *INITiate:CONTinuous:ON* (continuously). The trigger source must be set to *INTernal* or *EXTernal* with the *TRIGger:SOURce* command. After each occurrence of the trigger event, a measurement is performed in all timeslots. A trigger event must be available for each frame when averaging is being performed.

In addition to the average power, the following quantities can optionally be output for each timeslot:

- Maximum power
- Minimum power
- A randomly selected sample

The *SENSe:AUXiliary* command is used to make the selection.

Trace (XTIME:POWer)

In the Trace mode, the envelope power can be recorded as a function of time. This is done by sampling power over a time interval that can be specified by the user (*SENSe:TRACe:OFFSet:TIME* and *SENSe:TRACe:TIME* commands) and then assigning the power values that have been determined to a number of pixels that are largely user-selectable (*SENSe:TRACe:POINts* command). The time interval represented by a pixel is obtained by dividing the trace length by $N-1$, where N is the number of pixels.

In the simplest case, each pixel is assigned a single sample value which fully characterizes it. If several sample values are assigned to a pixel, the following quantities can be determined for each time interval:

- Average power
- Maximum power
- Minimum power
- A randomly selected sample

The *SENSe:AUXiliary* command is used to make the selection. Individual sample values cannot be accessed.

When the averaging function is deactivated (*SENSe:TRACe:AVERage:STATe OFF*) or an averaging factor of one has been selected, measurements are performed without chopper stabilization, i.e. a measurement consists of a single sampling sequence activated by a trigger event. Otherwise, the detector's output-voltage polarity is reversed automatically for alternate sampling sequences. This suppresses low-frequency noise and increases the accuracy with which the average power is measured at each pixel. Averaging has no effect on the randomly selected samples; the largest values for each averaging sequence are output as peak values.

In the *Trace* mode, the video bandwidth can be reduced step-by-step (*SENSe:BWIDth:VIDeo* command) to cut noise and increase trigger sensitivity.

Statistics (CCDF, PDF)

In both *Statistics* modes, either the complementary cumulative distribution function (CCDF) or the probability density function (PDF) of the envelope power can be measured. The following measurement parameters can be set:

- Start of analysis window (*STATistics:OFFSet:TIME* command)
- Length of analysis window (*STATistics:TIME* command)
- Exclusion period within analysis window (*STATistics[:EXCLude]:MID* command group)
- Number of analysis window repetitions (*SENSe:TRACe:AVERAge:COUNt* command)
- Video bandwidth (*SENSe:BWIDth:VIDeo* command group)

Statistical analysis can either be triggered by a signal (*TRIGger:SOURce INTernal|EXTernal* command) or is performed continuously (*TRIGger:SOURce IMMEDIATE* command). In the first case, analysis is synchronized to the signal characteristic, but not in the second case, i.e. a sequence of analysis windows is used. Analysis is terminated when the specified number of repetitions has been reached. Statistical analysis can be performed only when chopper stabilization is deactivated.

The sample size, i.e. the number of samples analyzed, equals the product of the analysis-window length, the number of repetitions and the sampling rate. In turn, the sampling rate is a function of the video bandwidth that has been set (*SENSe:BWIDth:VIDeo* command).

Before the analysis result can be output, the user must specify a level range and its resolution in pixels. For each pixel, either the value of the complementary cumulative distribution function or the value of the probability density function (in W^{-1}) is output. The following output parameters can be set:

- Lower limit of level range in dBm (*STATistics:SCALE:X:RLEVel* command)
- Width of level range in dB (*STATistics:SCALE:X:RANGe* command)
- Resolution in pixels (*STATistics:SCALE:X:POINts* command)

The size of the level interval represented by each pixel is determined by dividing the width of the level range by the number of pixels minus one. The smallest possible interval size for the R&S NRP-Z81/85/86 power sensor is specified as 0.006 dB. It can be queried with the *SENSe:STATistics:SCALE:X:MPWidth?* command.

SENSe:POWer:AVG:APERture[?] 1.0e-6 ... 1.0

SENSe:POWer:AVG:APERture defines the length of the time interval used to measure the average signal power in the *Continuous Average* mode (sampling window). For an unmodulated signal, the default setting of 10 μ s in conjunction with chopper stabilization provides optimum noise suppression. For a specified measurement-result noise-content, the minimum measurement time can therefore be obtained with this setting. Due to the narrow sampling window, averaging factors up to 2^{20} may be required at the lower end of the measurement range (-60 dBm).

Wider sampling windows are required when the measurement result exhibits variations due to modulation. In this case, it is beneficial to set the sampling-window length so that it is exactly equal to the modulation period; this provides a display with optimum stability. If the modulation period varies, or is not exactly known, smoothing (see command group *SENSe:POWer:AVG:SMOothing*) should also be activated. Approx. five periods within one sampling window are sufficient to reduce variations due to modulation to an acceptable level; variations with more than nine periods are no longer perceptible. With smoothing deactivated, the situation is significantly worse. In this case, 300 periods instead of five are required and variations completely disappear with 3000 or more periods.

The query returns the currently set length of the sampling window in seconds.

Default setting: 10.0e-6 [s]

SENSe:POWer:AVG:BUFFer:SIZE[?] 1 to 8192

SENSe:POWer:AVG:BUFFer:SIZE sets the buffer size for the buffered *Continuous Average* mode.

The query returns the current buffer size for the buffered *Continuous Average* mode.

Default setting: 1

SENSe:POWer:AVG:BUFFer:STATe[?] OFF | ON

The buffered *Continuous Average* mode is activated with *ON* and deactivated with *OFF*. In the buffered mode, measurement results generated by trigger events are buffered in the sensor until the buffer is full. All results are then transferred as block data. The effective measurement rate obtained is thus higher than in the non-buffered *Continuous Average* mode. The maximum measurement rate is obtained by combining the buffered mode with multiple triggering (see parameter *TRIGger:COUNt*). The size of the result buffer is set with the *SENSe:POWer:AVG:BUFFer:SIZE* command.

The query returns

- 1 for *OFF*
- 2 for *ON*

Default setting: *OFF*

SENSe:POWer:AVG:SMOothing:STATe[?] OFF | ON

The *ON* parameter activates a smoothing filter for modulated signals in the *Continuous Average* mode and *OFF* deactivates it. The smoothing filter is a steep-slope digital lowpass filter used to suppress result variations due to modulation. This parameter should be activated to reduce result variations due to modulation when the size of the sampling window cannot, or should not, be set to exactly equal the modulation period. If the selected sampling window is 5 to 9 times larger than a modulation period, the display variations are usually sufficiently reduced. With smoothing deactivated, 300 to 3000 periods are required to obtain the same effect.

When smoothing is deactivated, the sampling values are considered to be equivalent and averaged in a sampling window, which means that the measuring instrument acts as an integrator. As described above, optimum suppression of result variations is obtained when the size of the sampling window exactly equals the modulation period. Otherwise, modulation can have a considerable influence, even if the sampling window is much larger than the modulation period. The response can be considerably improved by weighting samples (raised von Hann window), which is equivalent to video filtering. This is exactly what happens when smoothing is activated.

Since the smoothing filter increases the inherent noise of the sensor by approx. 20%, it should always be deactivated if not required.

The query returns

- 1 for *OFF*
- 2 for *ON*

Default setting: *OFF*

SENSe:POWer:BURSt:DTOLerance[?] 0.0 to 0.3

SENSe:POWer:BURSt:DTOLerance defines the dropout tolerance, a parameter for reliably detecting the end of the burst in the *Burst Average* mode when signals are modulated (e. g. with digital standards

NADC, PDC, PHS, etc). The dropout tolerance should be selected to be larger than the greatest amplitude drop and smaller than the gap between two consecutive bursts. The default value is sufficient for all common digital communications standards.

The query returns the dropout tolerance for the *Burst Average* mode.

Default setting: 1.0e-6 [s]

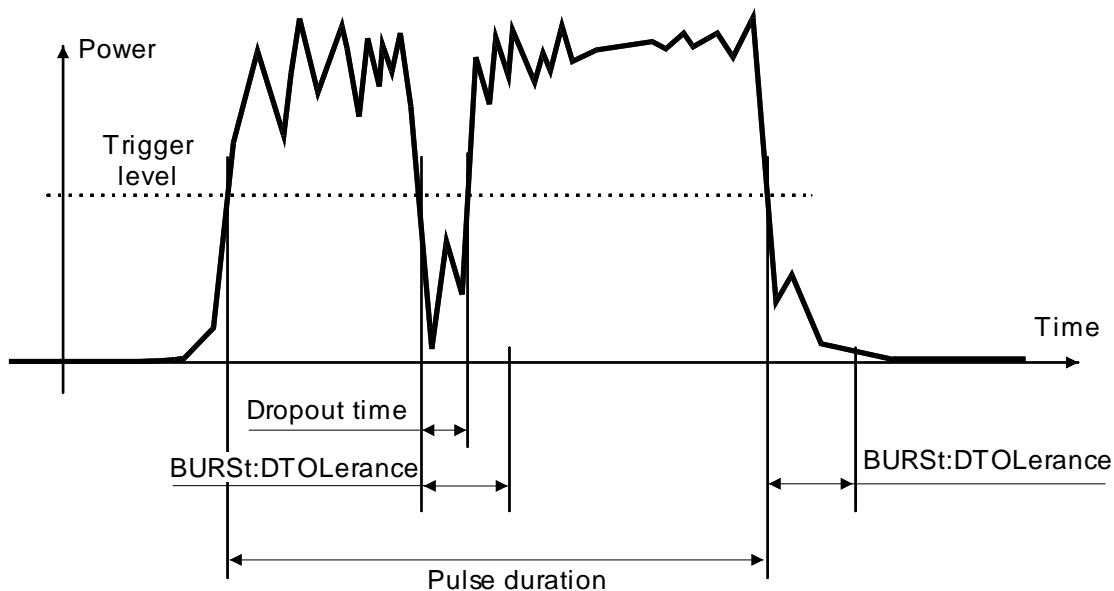

Fig. 6-1 Effect of *SENSe:POWer:BURSt:DTOLerance*

SENSe:POWer:TSLot[:AVG]:COUNT[?] 1 to 16

For the *Timeslot Average* mode, *SENSe:POWer:TSLot:AVG:COUNT* sets the number of consecutive timeslots that are to be processed after each trigger event.

The query returns the number of consecutive timeslots.

Default setting: 1

SENSe:POWer:TSLot[:AVG][:EXCLude]:MID:OFFSet[:TIME][?] 0.0 to 0.1

In the *Timeslot Average* mode, *SENSe:POWer:TSLot[:AVG][:EXCLude]:MID:OFFSet[:TIME]* is used to set the start of an exclusion interval in a timeslot. In conjunction with the command *SENSe:POWer:TSLot[:AVG][:EXCLude]:MID:TIME*, it is possible to exclude, for example, a midamble from the measurement. The start of the timeslot is used as the reference point for defining the start of the exclusion interval and this applies to each of the timeslots. In Fig. 6-2, this parameter is designated as T_{OFFSET} .



If the specified value is greater than the length of a timeslot, it is ignored. No error message is output.

The query command returns the start of the exclusion interval in a timeslot in seconds.

Default setting: 0 [s]

SENSe:POWer:TSLot[:AVG][:EXCLude]:MID:TIME[?] 0.0 to 0.1

In the *Timeslot Average* mode, `SENSe:POWer:TSLot[:AVG][:EXCLude]:MID:TIME` is used to specify the length of an exclusion interval in a timeslot. In conjunction with the command `SENSe:POWer:TSLot[:AVG][:EXCLude]:MID:OFFSEt[:TIME]`, it can be used, for example, to exclude a midamble from the measurement. The parameter applies to each individual timeslot. In Fig. 6-2, this parameter is designated as T_{LENGTH} .



Even if the exclusion interval exceeds the timeslot because, for example, its right limit is outside the timeslot, correct results are obtained. In the extreme case, where the interval length has been set to a value greater than the timeslot length, 0 W is output as the measured power. No error message is output.

The query command returns the length of the exclusion interval in seconds in a timeslot.

Default setting: 0 [s]

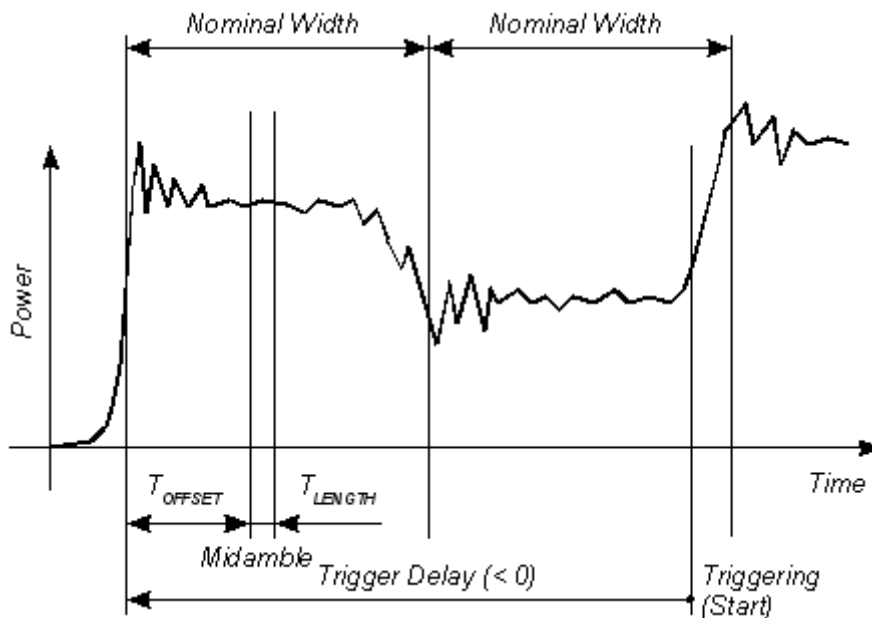

Fig. 6-2 Effect of an exclusion interval in the Timeslot mode

SENSe:POWer:TSLot[:AVG]:WIDTh[?] 50e-9 to 0.1

`SENSe:POWer:TSLot[:AVG]:WIDTh` sets the length of a timeslot for the *Timeslot Average* mode.

The query returns the length of a timeslot in seconds.

Default setting: 0.0001 [s]

SENSe:SGAMma:CORRection:STATe[?] OFF | ON

SENSe:SGAMma:CORRection:STATe ON initiates the use of the complex reflection coefficient Γ_{source} of the signal source defined with *SENSe:SGAMma:MAGNitude* and *SENSe:SGAMma:PHASe* for the correction of interactions between the power sensor and the signal source. This makes it possible to determine the power P delivered by the signal source with considerably greater accuracy.

The complex reflection coefficient Γ_{sensor} of the sensor, which is also required for the correction, is prestored in the calibration data memory for a large number of frequencies.

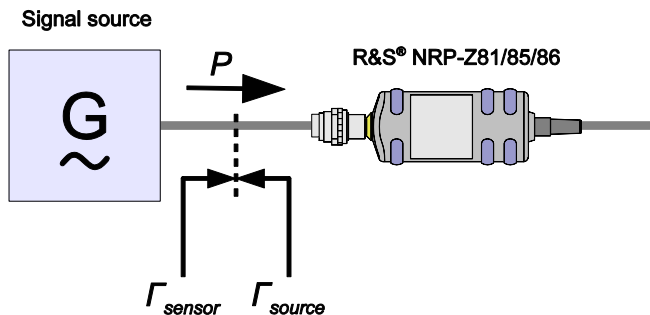

Fig. 6-3 Correction of interactions between the power sensor and the signal source

If the gamma correction is made in connection with an s-parameter correction (setting *SENSe:CORRection:SPDevice:STATe ON*), the interaction of the signal source with the s-parameter device on the one hand and the input of the power sensor on the other hand (depending on the magnitude of the term $|s_{12} s_{21}|$) is corrected. The interaction between the complex reflection coefficient Γ_{sensor} of the power sensor and the parameter s_{22} is always taken into account when the s-parameter correction is activated – independent of the gamma correction in connection with the signal source.

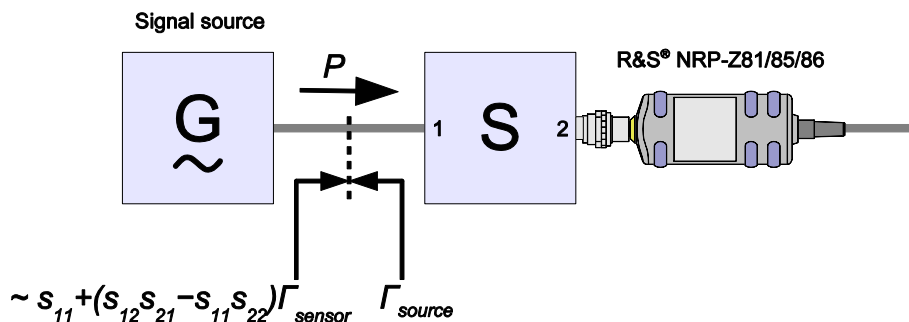

Fig. 6-4 Correction of interactions between the power sensor, the signal source, and the s-parameter device

The query yields

- 1 for OFF,
- 2 for ON.

Default setting: OFF

SENSe:SGAMma:MAGNitude[?] 0.0 to 1.0

SENSe:SGAMma:MAGNitude defines the magnitude of the complex reflection coefficient of the source. A value of 0.0 corresponds to an ideal matched source and a value of 1.0 to total reflection.

The query returns the set magnitude.

Default setting: 0.0

SENSe:SGAMma:PHASe[?] -360.0 to 360.0

SENSe:SGAMma:MAGNitude defines the phase angle (in degrees) of the complex reflection coefficient of the source.

The query returns the set phase angle.

Default setting: 0.0 [°]

SENSe:STATistics[:EXCLude]:MID:OFFSet[:TIME][?] 0.0 to 0.3

For both *Statistics* modes, this command is used to specify the start of an exclusion interval in the analysis window. The start time is referenced to the start of the analysis window. All other details are the same as for the *Timeslot Average* mode

(see *SENSe:POWer:TSLot[:AVG][:EXCLude]:MID:OFFSet[:TIME][?]* command).

Default setting: 0 [s]

SENSe:STATistics[:EXCLude]:MID:TIME[?] 0.0 to 0.3

For both *Statistics* modes, this command is used to specify the length of an exclusion interval in the analysis window. All other details are the same as for the *Timeslot Average* mode

(see *SENSe:POWer:TSLot[:AVG][:EXCLude]:MID:TIME[?]* command).

Default setting: 0 [s]

SENSe:STATistics:OFFSet:TIME[?] 0.0 to 10.0

In both *Statistics* modes, *SENSe:STATistics:OFFSet:TIME* is used to specify the start of the analysis window for recording measured values. The start time is referenced to the delayed trigger point (*TRIGger:DElay* command). Only positive values are valid. If the analysis window starts before the physical trigger point, the trigger delay must be set to a negative value with a suitably large magnitude (minimum magnitude -51.2 μs).

The query command returns the set time in seconds.

Default setting: 0.0 [s]

SENSe:STATistics:SCALE:X:MPWidth?

In both *Statistics* modes, this command is used to query the greatest attainable level resolution. For the R&S NRP-Z81/85/86 power sensor, this value is fixed at 0.006 dB per pixel. If this value is exceeded, a "Settings conflict" message is output. The reason for the conflict may be that the number of pixels that has been selected is too great or that the width chosen for the level range is too small (*SENSe:STATistics:SCALE:X:POINts* und *SENSe:STATistics:SCALE:X:RANGe* commands).

SENSe:STATistics:SCALE:X:POINts[?] 3 to 8191

SENSe:STATistics:SCALE:X:POINts is used to set the measurement-result resolution in both *Statistics* modes. This command specifies the number of pixels that are to be assigned to the logarithmic level range (*SENSe:STATistics:SCALE:X:RANGe* command) for measured value output. The width of the level range divided by N-1, where N is the number of pixels, must not be less than the value which can be read out with *SENSe:STATistics:SCALE:X:MPWidth?*

The query command returns the number of pixels for both *Statistics* modes.

Default setting: 200

SENSe:STATistics:SCALe:X:RANGe[?] 0.01 to 100

SENSe:STATistics:SCALe:X:RANGe is used to specify the width of the level range for the analysis result in both *Statistics* modes.

The query returns the set level range in dB.

Default setting: 50 [dB]

SENSe:STATistics:SCALe:X:RLEVel[?] -80 to +20

SENSe:STATistics:SCALe:X:RLEVel is used to define the lower limit of the level range for the analysis result in both *Statistics* modes. This level can be assigned to the first pixel. The level assigned to the last pixel is equal to the level of the first pixel plus the level range.

The query returns the lower limit of the level range for the *Statistics* modes.

Default setting: -30 [dBm]

SENSe:STATistics:TIME[?] 10.0e-6 to 0.3

SENSe:STATistics:TIME is used to set the duration of the analysis window for both *Statistics* modes.

The query command returns the time-window duration in seconds.

Default setting: 0.01 [s]

SENSe:TIMing:EXCLude:STARt[?] 0.0 to 10

SENSe:TIMing:EXCLude:STARt defines an exclusion time at the beginning of the measurement window in the *Burst Average* and *Timeslot Average* modes. It is referred to as " T_{START} " in Fig. 6-5 and Fig. 6-6.

The query returns the exclusion time at the beginning of the measurement window.

Default setting: 0.0 [s]

SENSe:TIMing:EXCLude:STOP[?] 0.0 to 51.2e-6

SENSe:TIMing:EXCLude:STOP defines an exclusion time at the end of the measurement window in the *Burst Average* (Fig. 6-5) and *Timeslot Average* (Fig. 6-6) modes. It is referred to as " T_{STOP} " in Fig. 6-5 and Fig. 6-6.

The query returns the exclusion time at the end of the measurement window.

Default setting: 0.0 [s]



If the exclusion times defined with *EXCLude:STARt* and *EXCLude:STOP* overlap, a "Settings conflict" message is output.

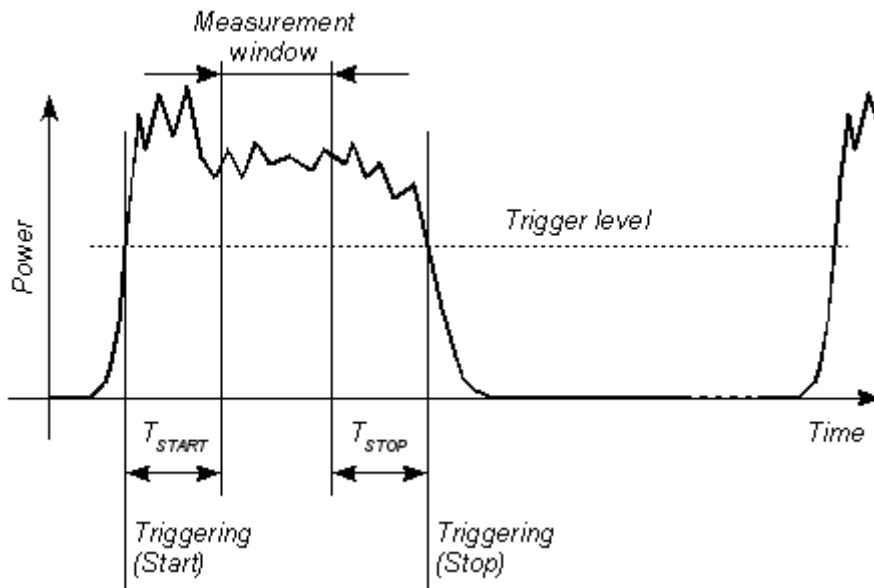

Fig. 6-5 Effect of `SENSe:TIMing:EXCLude:STARt` and `:STOP` in the *Burst Average* mode

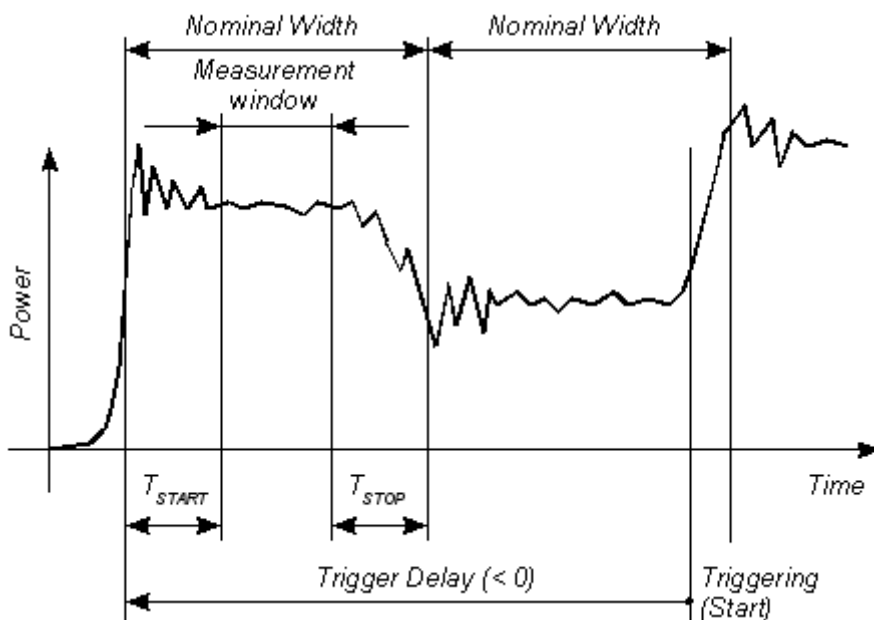

Fig. 6-6 Effect of `SENSe:TIMing:EXCLude:STARt` and `:STOP` in the *Timeslot* mode

SENSe:TRACe:AVERAge:COUNT[?] 1 to 65536

`SENSe:TRACe:AVERAge:COUNT` is used to set the averaging factor, i.e. the number of traces to be evaluated in the *Trace* mode and the number of timegates to be analyzed in the *Statistics* modes. In the *Trace* mode, the type of evaluation depends on the measurement result required for a pixel (`SENSe:AUXiliary` command):

Average power: The power values of identical measurement points, i.e. points at the same distance from the trigger point, are averaged. This reduces noise, the noise reduction being proportional to the square root of the averaging factor.

- Max./min. values: The maximum and minimum of all samples taken at identical measurement points, i.e. points at the same distance from the trigger point, are found and output.
- Random values: The random values are obtained from the first measurement cycle. Repetition of the measurement cycle has no effect on the result.

In the *Statistics* modes, the averaging factor is used to define sample size. For example, a sample size of 10^6 is required and the analysis window has a length of 100 μ s. If the sampling rate is 80 Msamples/s, at least 125 analysis windows will be required. As the averaging factor can only be set in powers of two on the sensors, 128 should be chosen.

The general rule is: The higher the averaging factor, the less the fluctuations in the measured values (with the exception of the random samples in the *Trace* mode) and the longer the total measurement time.

The averaging factor set by this command is rounded to the nearest power-of-two by the sensor.

The query returns the averaging factor set by the sensor



Averaging factors greater than one must be activated with the `SENSe:TRACe:AVERAge:STATe ON` command.

Default setting: 1

SENSe:TRACe:AVERAge:STATe[?] OFF | ON

`SENSe:TRACe:AVERAge:STATe ON` enables evaluation of several traces in the *Trace* mode or of several windows in the *Statistics* modes. The number of traces / windows (*averaging factor*) is defined by the `SENSe:TRACe:AVERAge:COUNT` command.

The query returns

- 1 for *OFF*
- 2 for *ON*

Default setting: *ON*

SENSe:TRACe:AVERAge:TCONtrol[?] MOVing | REPeat

`SENSe:TRACe:AVERAge:TCONtrol` (*terminal control*) defines how the measurement results are to be output in the *Trace* or *Statistics* modes if an averaging factor greater than one has been activated.

The *REPeat* parameter specifies that a measurement result is output only after the whole measurement has been completed. This means that the number of measurement cycle repetitions is equal to the set averaging factor. If the averaging factor is large, the measurement time can be very long.

When settings are made with the *MOVing* parameter, intermediate values are output to facilitate early detection of changes in the measured quantity. In the settled state - i.e. the number of measurements specified by the averaging factor has been carried out - a moving average is output in the *Trace* mode. In the *Statistics* modes, every measurement output is based on a sample size that has been previously defined. The `SYStem:RUTime` command can be used to vary the output rate over a wide range so that some intermediate results can be ignored.

The query returns

- 1 for *MOVing*
- 2 for *REPeat*

Default setting: *REPeat*

SENSe:TRACe:ESAMpling:AUTO[?] OFF | ON

The command *SENSe:TRACe:ESAMpling:AUTO ON* enables the automatic *equivalent sampling*. With this setting, the sensor will – depending on certain parameters – superpose several successive measurements to facilitate a high-resolution trace representation. However, this requires a periodic measurement signal and has a negative effect on measurement speed. Thus, the automatic *equivalent sampling* can be disabled with the command *SENSe:TRACe:ESAMpling:AUTO OFF*.

The query returns

- 1 for *OFF*,
- 2 for *ON*.

Default setting: *ON*

SENSe:TRACe:MEASurement:ALGorithm [?] HISTogram | INTegration | PEAK

This command is used to select the analysis algorithm for determining the pulse top and pulse base power.

The default setting *HISTogram* determines the pulse top and pulse base power by means of the probability density of instantaneous values of the recorded trace. However, if the quality of the signal is such that pulse top and pulse base cannot be identified, then the maximum and minimum values of the trace are used as pulse top and pulse base power. For most waveforms the *HISTogram* algorithm provides useful values and is preferable to the *INTegration* algorithm.

With the *INTegration* algorithm, the measured trace is first approximated by an ideal pulse representation with the same energy content, pulse duration and period. Pulse top power and pulse base power are then determined using this ideal pulse representation. This algorithm is recommended for radar pulses as well as pulses or bursts with time-variant envelope, e.g. EDGE bursts.

With the *PEAK* setting, the absolute maximum and the absolute minimum are used as pulse peak power and pulse base power, respectively. This algorithm is suitable for DME pulses.

The query returns

- 1 for *HISTogram*,
- 2 for *INTegration*,
- 3 for *PEAK*.

Default setting: *HISTogram*

SENSe:TRACe:MEASurement:AUTO[?] OFF | ON

SENSe:TRACe:MEASurement:AUTO ON is used to automatically transfer the measured pulse parameters after each trace. This enables a synchronous display of the trace and the pulse data during a continuous measurement with *INITiate:CONTInuous ON*.

The query returns

- 1 for *OFF*,
- 2 for *ON*.

Default setting: *OFF*

SENSe:TRACe:MEASurement:DEFine:DURation:REFerence[?] 0.0 ... 100.0

This command defines the level used to measure the pulse duration and period. This level is set in percent of the pulse amplitude which is defined as the difference of pulse top power and pulse base power.

The query returns the set level in percent of the pulse amplitude.

Default setting: 50 [%]

SENSe:TRACe:MEASurement:DEFine:TRANSition:HREFerence[?] 0.0 ... 100.0

This command defines the upper reference level that is used to measure the rise and fall times. This level is set in percent of the pulse amplitude which is defined as the difference of pulse top power and pulse base power.

The query returns the set level in percent of the pulse amplitude.

Default setting: 90 [%]

SENSe:TRACe:MEASurement:DEFine:TRANSition:LREFerence[?] 0.0 ... 100.0

This command defines the lower reference level that is used to measure the rise and fall times. This level is set in percent of the pulse amplitude which is defined as the difference of pulse top power and pulse base power.

The query returns the set level in percent of the pulse amplitude.

Default setting: 10 [%]

SENSe:TRACe:MEASurement:OFFSet:TIME[?] -x to 10.0

This command defines the start time of the pulse analysis referenced to the delayed trigger point (settable with the *TRIGger:DElay* command). As standard, the parameters of the first pulse detected within a trace are determined. This command is used to allow the parameters of a pulse other than the first in a trace to be determined. In this case, the pulse analysis must not begin until shortly before this pulse.

The query returns the start time of the pulse analysis referenced to the start of the trace measurement.

Default setting: 0.0 [s]

SENSe:TRACe:MEASurement:POWER:AVG?

This query returns the average power of the measurement signal in watts (Fig. 6-7) if the sensor is operated in *Trace* mode. For this, it is necessary that the analysis interval contains at least one full period of the measurement signal. If this is not the case, *NaN* (Not a Number) is returned.

SENSe:TRACe:MEASurement:POWER:HREFerence?

This query converts the upper reference level set with *SENSe:TRACe:MEASurement:DEFine:TRANSition:HREFerence* to an absolute power value in watts (Fig. 6-8).

SENSe:TRACe:MEASurement:POWer:LREFerence?

This query converts the lower reference level set with *SENSe:TRACe:MEASurement:DEFine:TRANsition:LREFerence* to an absolute power value in watts (Fig. 6-8).

SENSe:TRACe:MEASurement:POWer:MAX?

This query returns the maximum power value of a trace in watts (Fig. 6-7).

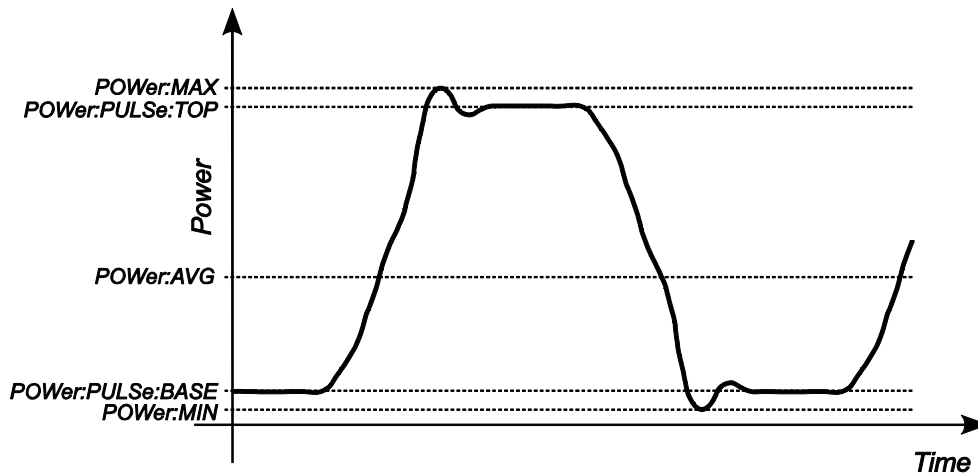

Fig. 6-7 Magnitude parameters of a trace

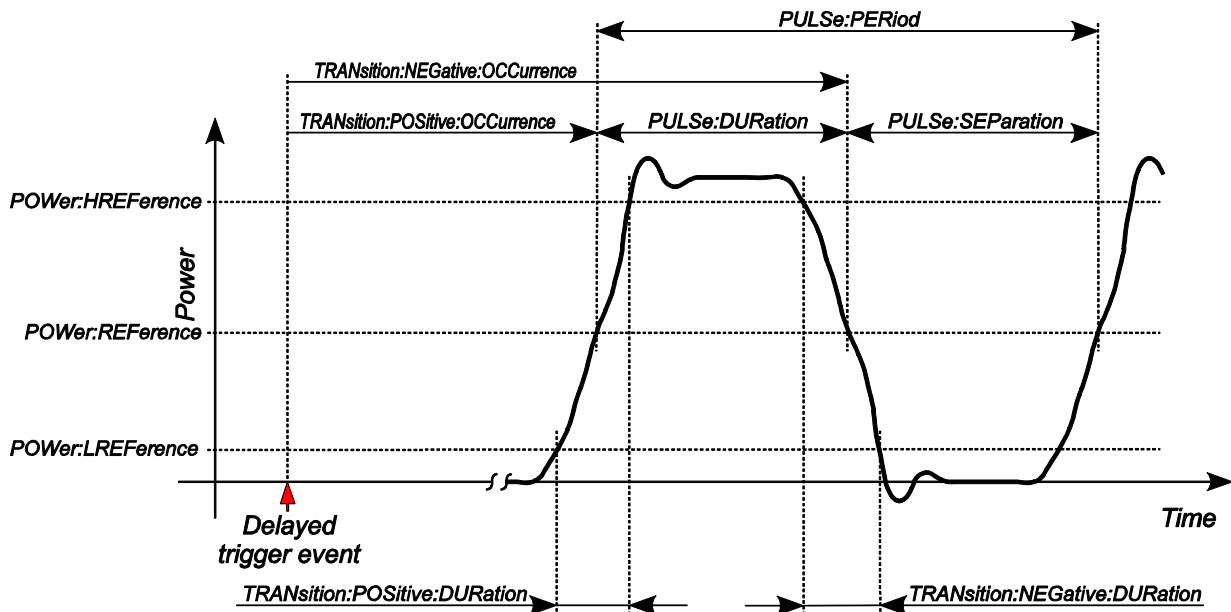

Fig. 6-8 Time parameters and reference levels of a trace

SENSe:TRACe:MEASurement:POWer:MIN?

This query returns the minimum power value of a trace in watts (Fig. 6-7).

SENSe:TRACe:MEASurement:POWer:PULSe:BASE?

This query returns the pulse base power in watts (Fig. 6-7).

SENSe:TRACe:MEASurement:POWer:PULSe:TOP?

This query returns the pulse top power in watts (Fig. 6-7).

SENSe:TRACe:MEASurement:POWer:REFerence?

This query converts the reference level set with *SENSe:TRACe:MEASurement:DEFine:DURation:REFerence* to an absolute power value in watts (Fig. 6-8).

SENSe:TRACe:MEASurement:PULSe:DCYCLE?

This query returns the duty cycle of the measured pulse signal in percent. If the pulse period – and thus the duty cycle – cannot be determined, *NaN* (Not a Number) is returned. The following equation applies:

$$\text{Duty cycle} = (\text{pulse duration} / \text{pulse period}) * 100 [\%]$$

SENSe:TRACe:MEASurement:PULSe:DURation?

This query returns the pulse duration which is defined as the time difference between the first positive edge in the analysis interval and the subsequent negative edge of the pulse (Fig. 6-8). If the pulse duration cannot be determined, *NaN* (Not a Number) is returned.

SENSe:TRACe:MEASurement:PULSe:PERiod?

This query returns the pulse period which is defined as the time between two consecutive edges of the same polarity (Fig. 6-8). If the pulse period cannot be determined, *NaN* (Not a Number) is returned.

The algorithm can automatically detect double pulses and also in this case correctly determine the period, provided that the trace covers at least three complete periods.

SENSe:TRACe:MEASurement:PULSe:SEPARation?

This query returns the time between two pulses in seconds (Fig. 6-8). This corresponds to the time between the first negative and the subsequent positive edge. The following correlation applies:

$$\text{Separation} = \text{pulse period} - \text{pulse duration}$$

If the pulse duration cannot be determined, *NaN* (Not a Number) is returned.

SENSe:TRACe:MEASurement:STATe[?] OFF | ON

SENSe:TRACe:MEASurement:STATe switches the automatic pulse measurement in the *Trace* mode on or off. If pulse measurement is on, the sensor automatically determines the pulse parameters for the currently measured trace.

The query returns

- 1 for *OFF*,
- 2 for *ON*.

Default setting: *OFF*

SENSe:TRACe:MEASurement:TIME[?] 0.0 ... 10.0

This command defines the duration of the pulse analysis. A value of *0.0* means that the analysis interval starts at the time determined by *SENSe:TRACe:MEASurement:DEFine:OFFSet:TIME* after the start of the trace measurement and extends to the end of the trace measurement, i.e. it is not subject to additional restrictions. A value greater than *0.0* is used to limit the analysis interval to a time before the end of the trace measurement.

The query returns the duration of the pulse analysis or *0.0* if this function is disabled.

Default setting: *0.0 [s]* (no additional restrictions on analysis interval)

SENSe:TRACe:MEASurement:TRANSition:ESAMpling:AUTO[?] OFF | ON

The command *SENSe:TRACe:MEASurement:TRANSition:ESAMpling:AUTO ON* enables the automatic *equivalent sampling* for pulse measurement. With this setting, the sensor will – depending on certain parameters – superpose several successive measurements to facilitate a high-resolution pulse measurement. However, this requires a periodic measurement signal and has a negative effect on measurement speed. Thus, the automatic *equivalent sampling* for pulse measurement can be disabled with the command *SENSe:TRACe:MEASurement:TRANSition:ESAMpling:AUTO OFF*.

The query returns

- 1 for *OFF*,
- 2 for *ON*.

Default setting: *ON*

SENSe:TRACe:MEASurement:TRANSition:NEGative:DURation?

This query returns the fall time of the first falling edge in the analysis interval. The fall time is defined as the time from when the signal falls below the upper reference level (see *SENSe:TRACe:MEASurement:DEFine:TRANSition:HREFerence*) to when it falls below the lower reference level (see *SENSe:TRACe:MEASurement:DEFine:TRANSition:LREFerence*). If no falling edge can be detected, *NaN* (Not a Number) is returned.

SENSe:TRACe:MEASurement:TRANSition:NEGative:OCCurrence?

This query returns the point in time when the first falling edge in the analysis interval occurs (pulse stop time), i.e. the point in time at which the signal falls below the middle reference level (see *SENSe:TRACe:MEASurement:DEFine:DURation:REFerence*). The delayed trigger event serves as temporal reference. If no falling edge can be detected, *NaN* (Not a Number) is returned.

SENSe:TRACe:MEASurement:TRANSition:NEGative:OVERshoot?

This query returns the overshoot, i.e. the height of the local minimum, after a falling edge, in percent of the pulse amplitude which is defined as the difference of pulse top power and pulse base power. The search interval begins when the signal falls below the lower reference level (see *SENSe:TRACe:MEASurement:DEFine:TRANSition:LREFerence*) and ends half a period after that. The following correlation applies:

neg. Overshoot = (pulse base level – local minimum) / pulse amplitude * 100 [%]

SENSe:TRACe:MEASurement:TRANSition:POSitive:DURation?

This query returns the rise time of the first rising edge in the analysis interval. The rise time is defined as the time from when the signal exceeds the lower reference level (see *SENSe:TRACe:MEASurement:DEFine:TRANSition:LREFerence*) to when it exceeds the upper reference level (see *SENSe:TRACe:MEASurement:DEFine:TRANSition:HREFerence*). If no rising edge can be detected, *NaN* (Not a Number) is returned.

SENSe:TRACe:MEASurement:TRANSition:POSitive:OCCurrence?

This query returns the point in time when the first rising edge occurs (pulse start time), i.e. the point in time at which the signal exceeds the middle reference level (see *SENSe:TRACe:MEASurement:DEFine:DURation:REFerence*). The delayed trigger event serves as temporal reference. If no rising edge can be detected, *NaN* (Not a Number) is returned.

SENSe:TRACe:MEASurement:TRANSition:POSitive:OVERshoot?

This query returns the overshoot, i.e. the height of the local maximum, after a rising edge, in percent of the pulse amplitude which is defined as the difference of pulse top power and pulse base power. The search interval begins when the signal exceeds the upper reference level (see *SENSe:TRACe:MEASurement:DEFine:TRANSition:HREFerence*) and ends half a period after that. The following equation applies:

pos. Overshoot = (local maximum – pulse top level) / pulse amplitude * 100 [%]

SENSe:TRACe:MEASurement:TRANSition:SPERiod?

This query returns the resolution of the temporal pulse parameters in seconds. The actual value is dependent on the settings and the measurement signal.

SENSe:TRACe:MPWidth?

This query returns the sampling interval for the *Trace* mode and the *Statistics* modes. It is equal to the reciprocal of the sampling rate and determines the effective time resolution when the measurement signal is sampled. The sampling rate and the sampling interval change when the video-bandwidth setting is changed (*SENSe:BWIDth:VIDeo* command).

SENSe:TRACe:OFFSet:TIME[?] -x to 10.0

SENSe:TRACe:OFFSet:TIME is used to specify the start of recording for the *Trace* mode. It is identical with the first pixel. The time associated with the last pixel is the time associated with the first pixel plus the trace length. The start of recording is referenced to the delayed trigger point (settable with the *TRIGger:DELay* command). Negative values indicate that the start of recording occurs before the delayed trigger point.

Due to the hardware limitations of the R&S NRP-Z81/85/86 power sensor, the recording cannot start at any point in time before the physical trigger event, i.e. the sum of the parameters *TRIGger:DELay* and *SENSe:TRACe:OFFSet:TIME* must be limited at the negative end. This limit corresponds to a length of 4096 pixels – in other words, it depends on the trace length and the number of points. Therefore, x may not exceed the following limit:

$$-x/s \leq - \left[\text{Trigger delay/s} + 4096 \times \frac{\text{Trace length/s}}{\text{Number of points}} \right]$$

Example: The trace length is 10 μ s for 200 points, the trigger delay being set to -5 μ s. This means that the start of recording can be set to occur max. 199.8 μ s before the delayed trigger point.

The formula above is exact only when the trace length and the number of points used to measure the signal can be queried with the *SENSe:TRACe:TIME:FPGA?* and *SENSe:TRACe:POINTs:FPGA?* commands. They always differ to some extent from the values obtained from the commands *SENSe:TRACe:TIME* and *SENSe:TRACe:POINTs*.

The query command returns the start of recording in seconds, referenced to the delayed trigger event.

Default setting: 0.0 [s]

SENSe:TRACe:POINTs[?] 3 to 8192

This command defines the time resolution for the measurement result in the *Trace* mode. Each point represents a time interval whose length is equal to the trace length (command *SENSe:TRACe:TIME*) divided by N-1, where N is the number of points. If this time interval is not an integer multiple of the sampling interval used internally by the sensor (*SENSe:TRACe:MPWidth?* query command), or is less than the internal sampling interval, all output values are obtained by linear interpolation, i.e. they are not based on an actual measurement. This processing step is performed automatically so that measurement result output can be defined without taking internal signal processing into account. All the same, this step is time-consuming and time resolution is not increased as a result.

Measurement times can always be minimized if the trace length and the number of points for the measurement result are chosen to match the internal values. The trace length and the number of points for the measurement result must first be set with the commands *SENSe:TRACe:TIME* and *SENSe:TRACe:POINTs*. The query commands *SENSe:TRACe:TIME:FPGA?* and *SENSe:TRACe:POINTs:FPGA?* are then used to obtain the values used internally so that the input values can be corrected accordingly.

The measurement result for a point comprises the average power plus max and min power or a random power sample, if selected with the command *SENSe:AUXiliary*.

The query returns the number of set points.

Default setting: 200

SENSe:TRACe:POINTs:FPGA?

SENSe:TRACe:POINTs:FPGA? can be used to query the number of points for the *Trace* mode used internally by the signal processing FPGA.

SENSe:TRACe:TIME[?] 50e-9 to 1

SENSe:TRACe:TIME sets the (trace length in the *Trace* mode.

The query returns the set time (in seconds).

Default setting: 0.01 [s]

SENSe:TRACe:TIME:FPGA?

SENSe:TRACe:TIME:FPGA? can be used to query the trace length for the *Trace* mode used internally by the signal processing FPGA.

SYSTEM

SYSTEM commands can be used to define and query administrative device settings. This includes detailed information about the sensor and its initialization and the transfer of available commands and their parameter limits.

Table 6-5 *SYSTEM* command group

Command	Parameter	Unit	Remarks
SYSTEM			
:FEATures?			Query only
:INFO? [Item]			Query only
:INITialize			No query
:LIMits?			Query only
:MINPower?		W	Query only
:RUTime	0.0 to 10.0	s	
:SUTime	0.0 to 10.0	s	
:TRANsaction			
:BEGin			No query
:END			No query

SYSTEM:FEATures?

This query prompts the sensor to output a complete list of all supported commands and parameters. This makes it possible to automatically adapt the remote-control software to the features of different types of sensor with different functionalities.

SYSTEM:INFO? [Item]

SYSTEM:INFO? returns a string containing information that is more detailed than the identification string output by the sensor in response to **IDN?*. If no *Item* is specified, the response string is a sequence with the format *Item:Information string* separated by *CR* and *LF* (in C notation: $\backslash\backslash$). The information associated with a particular item can be obtained by appending the appropriate *Item* option. The response string is zero-terminated, i.e. its end identifier is a zero byte (in C notation: $\backslash0$).

Table 6-6 Meaning of *Item* in the *SYSTEM:INFO?* command

Item	Information string	Remarks
"MANUFACTURER"	"Rohde & Schwarz"	Manufacturer
"TYPE"	"NRP-Z81" for R&S NRP-Z81 "NRP-Z85" for R&S NRP-Z85 "NRP-Z86" for R&S NRP-Z86	Type designation

Item	Information string	Remarks
"STOCK NUMBER"	"1137.9009.02" for R&S NRP-Z81 "1411.7501.02" for R&S NRP-Z85 "1417.0109.40" for R&S NRP-Z86 Var. 40 "1417.0109.44" for R&S NRP-Z86 Var. 44	Material number
"SERIAL"	"<serial number>"	6-digit serial number
"HWVERSION"	"000000000"	Hardware version (standard)
"HWVARIANT"	"000000000"	Hardware model (standard)
"SW BUILD"	"<build number>"	Version number of sensor firmware
"FPGA BUILD"	"<build number>"	Version number of FPGA firmware
"TECHNOLOGY"	"Diode"	Detector technology used
"FUNCTION"	"Power Terminating"	The R&S NRP-Z81/85/86 is a terminating power sensor.
"MINPOWER"	"<nominal lower test limit in W>"	The nominal lower test limit of the R&S NRP-Z81/85/86 is 1 nW, i.e. with S-parameter correction deactivated, the sensor returns the information string "1e-09" in response to <i>SYSTEM:INFo? "MINPOWER"</i> . With S-parameter correction activated, the information string depends on the nominal lower limit of the sensor/twoport combination.
"MAXPOWER"	"<nominal upper test limit in W>"	The nominal upper test limit of the R&S NRP-Z81/85/86 is 100 mW, i.e. with S-parameter correction deactivated, the sensor returns the information string "0.1" in response to <i>SYSTEM:INFo? "MAXPOWER"</i> . With S-parameter correction activated, the information string depends on the nominal upper limit of the sensor/twoport combination.
"MINFREQ"	"5e+07"	The minimum measurement frequency of the R&S NRP-Z81/85/86 is 50 MHz.
"MAXFREQ"	"1.8e+10" for R&S NRP-Z81 "4.0e+11" for R&S NRP-Z85 "4.0e+11" for R&S NRP-Z86 Var. 40 "4.4e+11" for R&S NRP-Z86 Var. 44	The maximum measurement frequency is 18 GHz for the R&S NRP-Z81 and 40 GHz for the R&S NRP-Z85/NRP-Z86 Var. 40.
"RESOLUTION"	"12.5ns"	The maximum time resolution in the Trace mode is 12.5 ns.
"IMPEDANCE"	"50"	The R&S NRP-Z81/85/86 RF input has a nominal input impedance of 50 Ω.
"COUPLING"	"AC"	The RF input of the R&S NRP-Z81/85/86 is AC-coupled.
"CAL. ABS."	"<date>"	Date of absolute calibration in the format YYYY-MM-DD. "Invalid Calibration Date" is returned if an invalid date is entered.
"CAL. REFL."	"<date>"	Date of reflection-coefficient calibration in the format YYYY-MM-DD. "Invalid Calibration Date" is returned if an invalid date is entered.
"CAL. S-PARA."	"<date>"	Date of S-parameter calibration in the format YYYY-MM-DD. If no S-parameter set is loaded, the sensor returns the string "not applicable". "Invalid Calibration Date" is returned if an invalid date is entered.

Item	Information string	Remarks
"CAL. MISC."	"<date>"	Date of calibration of other parameters in the format YYYY-MM-DD. "Invalid Calibration Date" is returned if an invalid date is entered.
"CAL. TEMP."	"<date>"	Date of detector characterization in the format YYYY-MM-DD. "Invalid Calibration Date" is returned if an invalid date is entered.
"CAL. LIN."	"<date>"	Date of linearity calibration in the format YYYY-MM-DD. "Invalid Calibration Date" is returned if an invalid date is entered.
"SPD MNEMONIC"	"<mnemonic string>"	Clear-text designation of the components connected ahead of the sensor.
"TESTLIMIT"	"0.160 dB"	Test limit for the automated test conducted by the NRP power meter base unit if s-parameter correction has been deactivated.
"TESTLIMIT PD."	"<testlimit>"	Test limit for the automated test conducted by the NRP power meter base unit if s-parameter correction has been activated (actual value dependent on s-parameters of the component connected ahead of the sensor).
"UPTIME"	"<uptime in s>"	Uptime of the power sensor since the last power-up/firmware update in seconds.

SYSTEM:INITialize

SYSTEM:INITialize sets the sensor to the standard state, i.e. the loading of default settings for all test parameters is the same as that for **RST*. The sensor then outputs a complete list of all supported commands and parameters. The command can be used to automatically adapt the remote-control software to the features of different types of sensor with different functionalities.

SYSTEM:LIMits?

This query prompts the sensor to output a complete list of all supported parameter value ranges. This makes it possible to automatically adapt the remote-control software to the features of different types of sensor with different functionalities.

SYSTEM:MINPower?

SYSTEM:MINPower? returns the lower test limit of the sensor, or of the sensor and the components connected ahead of it, if the *SENSe:CORRection:SPDevice* parameter has the value *ON*. This query can be used to determine an effective resolution for the result display near the lower test limit.

SYSTEM:RUTime 0 to 10.0

This command is used to limit the output rate when measurements are performed with continuous result output (setting *INITiate:CONTinuous ON*). This is useful if the measurement time is very short or if measurements are made with intermediate result output (*SENSe:AVERage:TCONtrol MOVing* or *SENSe:TRACe:AVERage:TCONtrol MOVing* command). If this limit is not set, the controlling host becomes overloaded very quickly or overly occupied with handling the output of measured values.

The parameter in the *SYSTem:RUTime* command is chosen to equal the required minimum interval between two consecutive measured value outputs. This equals the reciprocal of the output rate. If a measurement is known to take a long time, the output rate is cut accordingly.

SYSTem:SUTime 0 to 10.0

This command is used to reduce the frequency of the messages that are output when the sensor changes state from *WAIT_FOR_TRIGGER* to *MEASURING*.

Usually, the control unit is informed about this change of state. However, if measurement times are very short and/or trigger events occur very frequently, the data flows on the remote control connection can be very heavy and the control unit (or host) may not be able to handle them. The parameter *SUTime* can be used to define how long the power sensor shall remain in the *WAIT_FOR_TRIGGER* state without the associated status message being output.

Usually, *SUTime* is set to a value that is slightly less than the response time of the control system. This means that trigger events that have not occurred can still be detected in good time. At high trigger frequencies, this means that only the first transition to the *WAIT_FOR_TRIGGER* state and the subsequent transition into the *MEASURING* state are indicated by messages after the measurement is started. The next message will only indicate the return to the *IDLE* state on completion of the measurement.

SYSTem:TRANsaction:BEGiN

SYSTEM:TRANsaction:BEGiN marks the beginning of a sequence of setting commands whose parameter limits do not have to be checked. This prevents error messages from being displayed when a setting command causes a conflict that is resolved by a subsequent setting command. See *SYSTEM:TRANsaction:END*.

SYSTem:TRANsaction:END

SYSTEM:TRANsaction:END marks the end of a sequence of setting commands whose parameter limits do not have to be checked. This command reactivates parameter limit checks.

TEST

Table 6-7 TEST command group

Command	Parameter	Unit	Remarks
TEST:SENSor?			Query only

TEST:SENSor?

TEST:SENSor? triggers a sensor selftest. Unlike **TST*, this command returns detailed information which is useful for troubleshooting.



No signal may be applied to the sensor while the selftest is running.

If the selftest is carried out with a signal connected, error messages may erroneously be output for the test steps "Offset Voltages" and/or "Noise Voltage".

TRIGger

Table 6-8 TRIGger command group

Command	Parameter	Unit	Remarks
ABORt			No query
INITiate			
:CONTInuous[?]	OFF ON		
:IMMediate			No query
TRIGger			
:ALEVel:STATe[?]	OFF ON		
:ATRigger:STATe[?]	OFF ON		
:COUNT[?]	1 to 2×10^9		
:DELay[?]	-51.2e-6 to 10.0	s	
:DTIME[?]	0.0 to 10.0	s	
:HOLDoff[?]	0.0 to 10.0	s	
:HYSTeresis[?]	0.0 to 10.0	dB	
:IMMediate			No query
:LEVel[?]	1.0e-6 to 0.1	W	
:MASTER:STATe[?]	OFF ON		
:SLOPe[?]	POSitive NEGative		
:SOURce[?]	HOLD IMMediate INTernal BUS EXTernal		
:SYNChronisation:STATe[?]	OFF ON		

ABORt

ABORt interrupts the current measurement and sets the sensor to the *IDLE* state (normal case). However, if the sensor is in the continuous measurement mode (setting *INITiate:CONTInuous ON*), the *IDLE* state is immediately exited and the sensor enters the *WAIT_FOR_TRIGGER* state.

INITiate:CONTInuous[?] OFF | ON

INITiate:CONTInuous ON activates the continuous measurement mode. In this mode, a new measurement cycle is automatically started after the preceding one has been terminated. The sensor first enters the *WAIT_FOR_TRIGGER* state and begins the measurement as soon as the trigger condition is fulfilled. Depending on the number of trigger events that are required, e.g. for averaging, the *WAIT_FOR_TRIGGER* state can be entered several times. Once the whole measurement cycle is

completed, a measurement result is available and the sensor enters the *WAIT_FOR_TRIGGER* state again. The sensor will continue measuring if there are continuous trigger events.

If the continuous measurement mode is switched off by means of the *INITiate:CONTinuous OFF* command, single measurements can be started with the *INITiate:IMMEDIATE* command (see below).

The query returns

- 1 for *OFF*
- 2 for *ON*

Default setting: *OFF*

INITiate:IMMEDIATE

INITiate:IMMEDIATE starts a single measurement cycle. The sensor first changes from the *IDLE* state to the *WAIT_FOR_TRIGGER* state and begins the measurement as soon as the trigger condition is fulfilled. Depending on the number of trigger events that are required, e.g. for averaging, the *WAIT_FOR_TRIGGER* state can be entered several times. Once the whole measurement is completed, a measurement result is available and the sensor enters the *IDLE* state again. The *INITiate:IMMEDIATE* command should only be used after the continuous measurement mode has been switched off with the *INITiate:CONTinuous OFF* command.

TRIGger:ALEVel:STATe[?] OFF | ON

In the *Trace* mode, *TRIGger:ALEVel:STATe ON* activates the automatic setting of the trigger threshold for internal triggering (*TRIGger:SOURce INTernal*). This involves determining the smallest and the largest sample value within the trace length and setting the trigger threshold so that it lies exactly at the midpoint between these two values. If there are no trigger events for more than 0.3 seconds, an automatic search phase lasting 1 second is activated and then the trigger threshold is adjusted.

TRIGger:ALEVel:STATe OFF is used to disable the automatic setting of the trigger threshold for internal triggering. The last automatically determined setting is retained in this case.

The query command returns

- 1 for *OFF*
- 2 for *ON*

Default setting: *OFF*

TRIGger:ATRigger:STATe[?] OFF | ON

TRIGger:ATRigger:STATe ON generates an artificial trigger if more than 300 ms have elapsed after the start of measurement and no trigger event has been recorded. The command is only evaluated in the *Trace* mode and, irrespective of the set averaging factor, only one trace will be recorded. *TRIGger:ATRigger:STATe OFF* deactivates the automatic trigger function.

The query returns

- 1 for *OFF*
- 2 for *ON*

Default setting: *OFF*

TRIGger:COUNT[?] 1 to 2³¹

This setting is designed for applications where several consecutive measurements are performed by sending the *INITiate:IMMEDIATE* command only once, e.g. to obtain higher measurement speed. The gap between a single measurement and the continuous measurement mode is thus closed. The number of measurements is defined by the parameter associated with the *TRIGger:COUNT* command. This number equals the number of results obtained by the sensor at the end of the measurement. One result may contain several numerical values, e.g. power values for the trace points.



The TRIGger:COUNT command does not define the number of trigger events required to perform the entire measurement task. This number is either identical or an integer multiple if averaging has been activated.

*A further increase in the measurement speed can be obtained by entering the buffered mode as well (see command group *SENSe:POWer:AVG:BUFFer*). In this mode, the results are not made available immediately, but as a block at the end of the measurement cycle.*

The query returns the number of measurements to be performed after a measurement is started with the *INIT:IMMEDIATE* command.

Default setting: 1

TRIGger:DELAy[?] -x to 10.0

This command is used to set a trigger delay for all measurements in sync with the signal except in the *Burst Average* mode. It provides a time offset to the physical trigger event equal to the entered value. The trigger can thus be shifted to a point in time of the measurement signal that is significant for the measurement, for example to the start of the first timeslot for the *Timeslot Average* mode. If external triggering is used, delay differences between the external trigger signal and the measurement signal can be compensated for with a trigger delay.

It is possible to set negative trigger delays, i.e. the trigger point can occur before the physical trigger event. No matter which measurement mode is selected, the negative limit is $-51.2 \mu\text{s}$. If the trigger delay is entered in the *Trace* mode, an additional condition must be met: the sum of the start of recording and the trigger delay must not exceed the length of -4096 pixels (see notes on the *SENSe:TRACe:OFFSet:TIME* command). If full use is to be made of this value, it depends on the order in which the trigger delay and the start of recording are entered whether a trigger delay down to $-51.2 \mu\text{s}$ can be set. When a different measurement mode is selected, the full $-51.2 \mu\text{s}$ become immediately available again. When switching (back) to the *Trace* mode, the trigger delay that has been set is retained and, if there is a conflict, the start of recording is adjusted automatically.

In the *Timeslot Average* modes, the time resolution of the trigger delay is always 12.5 ns ; in the *Statistics* modes, it depends on the video bandwidth (see the *SENSe:BWIDth:VIDeo* command). In the *Trace* mode, it equals the length of a pixel as used for internal signal processing (see the *SENSe:TRACe:TIME:FPGA?* and *SENSe:TRACe:POINts:FPGA?* query commands).

Any trigger delay that is set comes into effect irrespective of the defined trigger source, but this is only useful with the *Internal* and *External* settings.

Default setting: 0.0 [s]

TRIGger:DTIME[?] 0.0 to 10.0

TRIGger:DTIME is used to set the dropout time in seconds. With a positive (negative) trigger slope, the dropout time is the minimum time for which the signal must be below (above) the power level defined by *TRIGger:LEVel* and *TRIGger:HYSTeresis* before triggering can occur again. As with the *Holdoff* parameter, unwanted trigger events can be excluded. The set dropout time only affects the *INTernal* trigger source.

The *dropout time* parameter is useful when dealing with, for example, GSM signals with several active slots (Fig. 6-9). When performing a measurement in sync with the signal, a trigger event is to be produced at A, but not at B or C. As the RF power between the slots is below the threshold defined by *TRIGger:LEVel* and *TRIGger:HYSTeresis*, the trigger hysteresis alone cannot prevent triggering at B or at C. This is why the *dropout time* parameter is selected to be greater than the time elapsed between points D and B and between E and C, but less than the time elapsed between F and A. This ensures that triggering will take place at A.

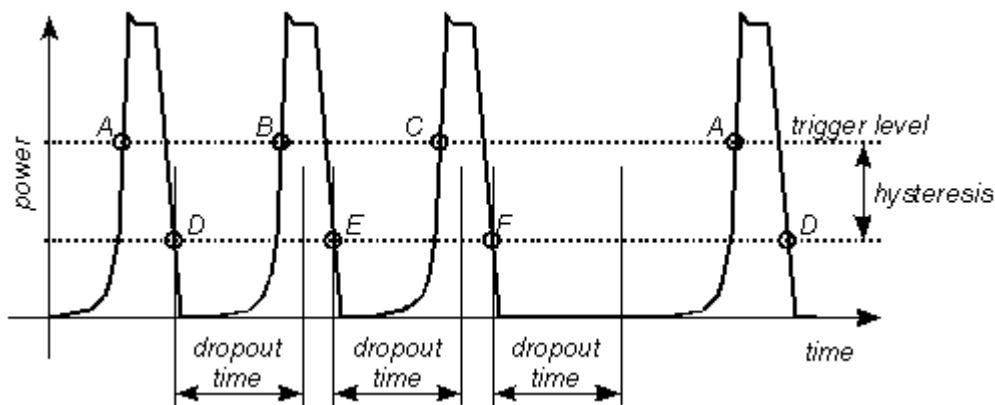

Fig. 6-9 Effect of the *dropout time* parameter

As the mechanism associated with the *dropout time* parameter is reactivated whenever the trigger threshold is crossed, unambiguous triggering can also be obtained for many complex signals. By contrast, all triggering is suppressed during the hold-off time. For the example described, this would mean that although stable triggering conditions could be obtained with a suitable hold-off time (regular triggering at the same point), it would not be possible to set exclusive triggering at A.

The query command returns the dropout time in seconds.

Default setting: *200.0e-9 [s]*

TRIGger:HOLDoff[?] 0.0 to 10.0

TRIGger:HOLDoff suppresses trigger events within the set hold-off time (in seconds), starting from the time of the last successful triggering.

The query returns the set hold-off time (in seconds).

Default setting: *0.0 [s]*

TRIGger:HYSTeresis[?] 0.0 to 10.0

TRIGger:HYSTeresis sets the hysteresis of the internal trigger threshold (parameter *TRIGger:LEVel*). Hysteresis is the magnitude (in dB) the trigger signal level must drop below the trigger threshold (positive trigger slope) before triggering can occur again. Exactly the opposite is the case with a negative trigger slope. The trigger hysteresis setting only applies to the *INTernal* trigger source.

The query returns the trigger hysteresis in dB.

Default setting: 0.0 [dB]

TRIGger:IMMediate

TRIGger:IMMediate triggers a generic trigger event that causes the sensor to immediately exit the *WAIT_FOR_TRIGGER* state irrespective of the trigger source and the trigger delay and start the measurement. The command is the only means of starting a measurement when the trigger source is set to *HOLD*. Only one measurement cycle is executed irrespective of the averaging factor.

TRIGger:LEVel[?] 1.0e-6 to 0.1

TRIGger:LEVel sets the trigger threshold (in W) for internal triggering derived from the test signal. This setting is irrelevant to all other trigger sources. If an S-parameter device has been activated, the trigger level setting is always referenced to the input of this device. When switching the S-parameter device on or off, the set trigger level and the entry limits are automatically adjusted.

The query returns the trigger threshold in W.

Default setting: 0.0001

TRIGger:MASTer:STATe[?] OFF | ON

TRIGger:MASTer:STATe ON can be used to configure an R&S NRP-Z81/85/86 power sensor as the trigger master, enabling it to output a digital trigger signal in sync with its own trigger event. This makes it possible to synchronize several sensors (see the *TRIGger:SYNChronisation:STATe* command) and to perform measurements in sync with a signal at very low power, which normally would not allow signal triggering. The trigger signal which is output has a length of 1µs and the positive slope coincides with the physical trigger point. At present, it can be distributed to other R&S NRP-Zxx sensors only via the R&S NRP base unit and not via the R&S NRP-Z3/-Z4 interface adapter.

Generally, the trigger master is set to internal triggering (signal triggering) (the *BUS* and *IMMEDIATE* settings can also be used); the sensors acting as trigger slaves (*TRIGger:MASTer:STATe OFF*, *TRIGger:SOURce:EXTernal*) must be set to external triggering and positive trigger slope.

With the R&S NRP-Z81/85/86 power sensor, digital trigger signals are sent and received via a single differential line pair, the trigger bus. Only one instrument on the trigger bus can act as the trigger master. If the application is time-critical, the trigger-signal delay from the master to a slave must be taken into account. Using the R&S NRP, the delay is about 30 ns.

The query returns

- 1 for *OFF*,
- 2 for *ON*.

Default setting: *OFF*

TRIGger:SLOPe[?] POSitive | NEGative

TRIGger:SLOPe defines the slope of the triggering signal to be evaluated with internal or external triggering. *Positive* means increasing envelope power (with internal triggering) or increasing voltage (with external triggering). This command has no effect in the *Burst Average* mode and when used with the *BUS*, *HOLD* and *IMMEDIATE* trigger sources.

The query returns

- 1 for *POSitive*
- 2 for *NEGative*

Default setting: *POSitive*

TRIGger:SOURce[?] HOLD | IMMEDIATE | INTERNAL | BUS | EXTERNAL

TRIGger:SOURce sets the trigger source.

- *HOLD*: Triggering only with the command *TRIGger:IMMEDIATE*.
- *IMMEDIATE*: Automatic triggering without explicit event.
- *INTERNAL*: Triggering by the measurement signal. Relevant parameters: *TRIGger:LEVEL*, *TRIGger:HYSteresis*, *TRIGger:DTIME*, *TRIGger:DELay*, *TRIGger:HOLDoff* and *TRIGger:SLOPe*.
- *BUS*: Triggering with the command **TRG* or *TRIGger:IMMEDIATE*.
- *EXTERNAL*: Triggering via a hardware trigger bus, i.e. R&S NRP-Z3 USB adapter or another power sensor, configured as a trigger master (currently only with the R&S NRP).
Relevant parameters:
TRIGger:DELay, *TRIGger:SLOPe*, *TRIGger:DTIME*,
TRIGger:HOLDoff and *TRIGger:SYNChronisation:STATE*

The query returns

- 1 for *HOLD*
- 2 for *IMMEDIATE*
- 4 for *INTERNAL*
- 8 for *BUS*
- 16 for *EXTERNAL*

Default setting: *IMMEDIATE*

TRIGger:SYNChronisation:STATE OFF | ON

TRIGger:SYNChronisation:STATE ON can be used to synchronize the sensors connected to the trigger bus (must currently be connected via the R&S NRP). Synchronization is achieved by enabling the trigger signal only when all the sensors are in the *WAIT_FOR_TRIGGER* state (wired-OR). This ensures that the measurements are started simultaneously and also that repetitions due to averaging start at the same time. It must be ensured that the number of repetitions is the same for all the sensors involved in the measurement. Otherwise, the trigger bus will be blocked by any sensor that has completed its measurements before the others and has returned to the *IDLE* state.

The synchronization function is turned off with *TRIGger:SYNChronisation:STATE OFF*.

Default setting: *OFF*

List of Remote-Control Commands

The syntax of the R&S NRP-Z81/85/86's remote-control commands is based to a limited extent on the SCPI 1999.0 standard.

Table 6-9 List of remote-control commands

Command	Parameter	Unit	Default setting	Page
* Commands				
*IDN?				6.2
*RST				6.2
*TRG				6.2
*TST?				6.2
CALibration Commands				
CALibration:DATA[?]	<calibration data set as definite length block>			6.3
CALibration:DATA:LENGth?		Bytes		6.3
CALibration:ZERO:AUTO[?]	LFR UFR ONCE			6.3
CALibration:ZERO:FAST:AUTO[?]	ONCE			6.4
SENSe Commands				
SENSe:AUXiliary[?]	NONE MINMAX RNDMAX		RNDMAX	6.10
SENSe:AVERAge:COUNT[?]	1 to 2 ²⁰		1024	6.10
SENSe:AVERAge:COUNT:AUTO[?]	OFF ON ONCE		ON	6.10
SENSe:AVERAge:COUNT:AUTO:MTIME[?]	1.0 to 999.99	s	4	6.11
SENSe:AVERAge:COUNT:AUTO:NSRatio[?]	0.0001 to 1.0	dB	0.01	6.11
SENSe:AVERAge:COUNT:AUTO:RESolution[?]	1 to 4		3	6.11
SENSe:AVERAge:COUNT:AUTO:SLOT[?]	1 to <SENSe:POWer:TSLot :AVG :COUNT>		1	6.11
SENSe:AVERAge:COUNT:AUTO:TYPE[?]	RESolution NSRatio		RESolution	6.11
SENSe:AVERAge:RESet				6.12
SENSe:AVERAge:STATe[?]	OFF ON		ON	6.12
SENSe:AVERAge:TCONtroll[?]	MOVing REPeat		REPeat	6.12

Command	Parameter	Unit	Default setting	Page
SENSe:BWIDth:VIDEo[?]	"300 kHz" "1.5 MHz" "5 MHz" "FULL"		"FULL"	6.13
SENSe:BWIDth:VIDEo:LIST?				6.12
SENSe:CORRection:DCYClE[?]	0.001 to 99.999	%	1.0	6.12
SENSe:CORRection:DCYClE:STATe[?]	OFF ON		OFF	6.13
SENSe:CORRection:OFFSet[?]	-200.0 to 200.0	dB	0.0	6.14
SENSe:CORRection:OFFSet:STATe[?]	OFF ON		OFF	6.14
SENSe:CORRection:SPDeVice:LIST?				6.14
SENSe:CORRection:SPDeVice:SELEct[?]	Consecutive number of the S-parameter device		1 (can be modified by the user)	6.14
SENSe:CORRection:SPDeVice:STATe[?]	OFF ON		OFF (can be modified by the user)	6.14
SENSe:FREQuency[?]	50.0e6 to 18.0e9 (NRP- Z81) ...40.0e9 (NRP-Z85, NRP-Z86 Var. 40) or ...44.0e9 (NRP-Z85, NRP- Z86 Var. 44)	Hz	1.0e9	6.15
SENSe:FUNctIon[?]	"POWer:AVG" "POWer:BUSt:AVG" "POWer:TSLot:AVG" "XTIME:POWer" "XPOWer:CCDFunction" "XPOWer:PDFunction"		"POWer:AVG"	6.15
SENSe:POWer:AVG:APERture[?]	1.0e-6 to 1.0	s	10.0e-6	6.18
SENSe:POWer:AVG:BUFFer:SIZE[?]	1 to 8192		1	6.19
SENSe:POWer:AVG:BUFFer:STATe[?]	OFF ON		OFF	6.19
SENSe:POWer:AVG:SMOothing:STATe[?]	OFF ON		OFF	6.19
SENSe:POWer:BUSt:DTOLerance[?]	0.0 to 0.3	s	1.0e-6	6.19
SENSe:POWer:TSLot[:AVG]:COUNt[?]	1 to 16		8	6.20
SENSe:POWer:TSLot[:AVG][:EXCLude]:MID:OFFSet [:TIME][?]	0.0 to 0.1	s	0.0	6.20
SENSe:POWer:TSLot[:AVG][:EXCLude]:MID:TIME[?]	0.0 to 0.1	s	0.0	6.20
SENSe:POWer:TSLot[:AVG]:WIDTh[?]	50e-9 to 0.1	s	0.0001	6.20
SENSe:SGAMma:CORRection:STATe[?]	OFF ON		OFF	6.22
SENSe:SGAMma:MAGNitude[?]	0.0 to 1.0		0.0	6.22
SENSe:SGAMma:PHASe[?]	-360.0 to 360.0	degree	0.0	6.23
SENSe:STATistics[:EXCLude]:MID:OFFSet[:TIME][?]	0.0 to 0.3	s	0.0	6.23

Command	Parameter	Unit	Default setting	Page
SENSe:STATistics[:EXCLude]:MID:TIME[?]	0.0 to 0.3	s	0.0	6.23
SENSe:STATistics:OFFSet:TIME[?]	0 to 10.0	s	0.0	6.23
SENSe:STATistics:SCALe:X:MPWidth?		dB		6.23
SENSe:STATistics:SCALe:X:POINts[?]	3 to 8191		200	6.23
SENSe:STATistics:SCALe:X:RANGe[?]	0.01 to 100.0	dB	50	6.24
SENSe:STATistics:SCALe:X:RLEVel[?]	-80 to +20	dBm	-30	6.24
SENSe:STATistics:TIME[?]	10.0e-6 to 0.3	s	0.01	6.24
SENSe:TIMing:EXCLude:STARt[?]	0.0 to 10.0	s	0.0	6.24
SENSe:TIMing:EXCLude:STOP[?]	0.0 to 51.2e-6	s	0.0	6.24
SENSe:TRACe:AVERAge:COUNT[?]	1 to 65536		1	6.25
SENSe:TRACe:AVERAge:STATe[?]	OFF ON		ON	6.26
SENSe:TRACe:AVERAge:TCONtrol[?]	MOVing REPeat		REPeat	6.26
SENSe:TRACe:ESAMpling:AUTO[?]	OFF ON		ON	6.27
SENSe:TRACe:MEASurement:ALGorithm [?]	HISTogram INTegration PEAK		HISTogram	6.27
SENSe:TRACe:MEASurement:AUTO[?]	OFF ON		OFF	6.27
SENSe:TRACe:MEASurement:DEFine:DURation:REFerence[?]	0.0 ... 100.0	%	50.0	6.28
SENSe:TRACe:MEASurement:DEFine:TRANsition:HREFerence[?]	0.0 ... 100.0	%	90.0	6.28
SENSe:TRACe:MEASurement:DEFine:TRANsition:LREFerence[?]	0.0 ... 100.0	%	10.0	6.28
SENSe:TRACe:MEASurement:OFFSet:TIME[?]	-x to 10.0	s	0.0	6.28
SENSe:TRACe:MEASurement:POWer:AVG?		W		6.28
SENSe:TRACe:MEASurement:POWer:HREFerence?		W		6.28
SENSe:TRACe:MEASurement:POWer:LREFerence?		W		6.29
SENSe:TRACe:MEASurement:POWer:MAX?		W		6.29
SENSe:TRACe:MEASurement:POWer:MIN?		W		6.29
SENSe:TRACe:MEASurement:POWer:PULSe:BASE?		W		6.30
SENSe:TRACe:MEASurement:POWer:PULSe:TOP?		W		6.30
SENSe:TRACe:MEASurement:POWer:REFerence?		W		6.30
SENSe:TRACe:MEASurement:PULSe:DCYClE?		%		6.30

Command	Parameter	Unit	Default setting	Page
SENSe:TRACe:MEASurement:PULSe:DURation?		s		6.30
SENSe:TRACe:MEASurement:PULSe:PERiod?		s		6.30
SENSe:TRACe:MEASurement:PULSe:SEParation?		s		6.30
SENSe:TRACe:MEASurement:STATe[?]	OFF ON		OFF	6.31
SENSe:TRACe:MEASurement:TIME[?]	0.0 ... 10.0	s	0.0 (disabled)	6.31
SENSe:TRACe:MEASurement:TRANSition:ESAMpling:AUtO[?]	OFF ON		ON	6.31
SENSe:TRACe:MEASurement:TRANSition:NEGative:DURation?		s		6.31
SENSe:TRACe:MEASurement:TRANSition:NEGative:OCCurrence?		s		6.31
SENSe:TRACe:MEASurement:TRANSition:NEGative:OVERshoot?		%		6.32
SENSe:TRACe:MEASurement:TRANSition:POSitive:DURation?		s		6.32
SENSe:TRACe:MEASurement:TRANSition:POSitive:OCCurrence?		s		6.32
SENSe:TRACe:MEASurement:TRANSition:POSitive:OVERshoot?		%		6.32
SENSe:TRACe:MEASurement:TRANSition:SPERiod?		s		6.32
SENSe:TRACe:MPWidth?		s		6.32
SENSe:TRACe:OFFSet:TIME[?]	-x to 10.0	s	0.0	6.32
SENSe:TRACe:POINts[?]	3 to 8192		200	6.33
SENSe:TRACe:POINts:FPGA?				6.33
SENSe:TRACe:TIME[?]	50.0e-9 to 1.0	s	0.01	6.34
SENSe:TRACe:TIME:FPGA?		s		6.34
SYSTem Commands				
SYSTem:FEATures?				6.35
SYSTem:INFO? [Item]				6.35
SYSTem:INITialize				6.37
SYSTem:LIMits?				6.37
SYSTem:MINPower?		W		6.37
SYSTem:RUTime	0 to 10.0	s		6.37

Command	Parameter	Unit	Default setting	Page
SYSTem:SUTime	0.0 to 10.0	s	1.0e-4	6.38
SYSTem:TRANsaction:BEgin				6.37
SYSTem:TRANsaction:END				6.38
Test Commands				
TEST:SENSor?				6.39
Triggersystem Commands				
ABORt				6.40
INITiate:CONTinuous[?]	OFF ON		OFF	6.40
INITiate:IMMediate				6.41
TRIGger:ALEVel:STATe[?]	OFF ON		OFF	6.41
TRIGger:ATRigger:STATe[?]	OFF ON		OFF	6.41
TRIGger:COUNt[?]	1 to 2e9		1	6.42
TRIGger:DELay[?]	-51.2e-6 to 10.0	s	0.0	6.42
TRIGger:DTIMe[?]	0.0 to 10.0	s	200.0e-9	6.43
TRIGger:HOLDoff[?]	0.0 to 10.0	s	0.0	6.43
TRIGger:HYSTeresis[?]	0.0 to 10.0	dB	0.0	6.44
TRIGger:IMMediate				6.44
TRIGger:LEVel[?]	1.0e-6 to 0.1	W	1e-4	6.44
TRIGger:MASTer:STATe[?]	OFF ON		OFF	6.44
TRIGger:SLOPe[?]	POSitive NEGative		POSitive	6.44
TRIGger:SOURce[?]	HOLD IMMediate INTernal BUS EXTernal		IMMediate	6.45
TRIGger:SYNChronisation:STATe	OFF ON		OFF	6.45